

Spring 2013

Utilization of booster fans in underground mines

Arash Habibi Javanbakht

Follow this and additional works at: http://scholarsmine.mst.edu/masters_theses



Part of the [Mining Engineering Commons](#)

Department: Mining and Nuclear Engineering

Recommended Citation

Habibi Javanbakht, Arash, "Utilization of booster fans in underground mines" (2013). *Masters Theses*. 7098.
http://scholarsmine.mst.edu/masters_theses/7098

This Thesis - Open Access is brought to you for free and open access by Scholars' Mine. It has been accepted for inclusion in Masters Theses by an authorized administrator of Scholars' Mine. This work is protected by U. S. Copyright Law. Unauthorized use including reproduction for redistribution requires the permission of the copyright holder. For more information, please contact scholarsmine@mst.edu.

UTILIZATION OF BOOSTER FANS IN UNDERGROUND MINES

by

ARASH HABIBI JAVANBAKHT

A THESIS

Presented to the Faculty of the Graduate School of the
MISSOURI UNIVERSITY OF SCIENCE AND TECHNOLOGY

In Partial Fulfillment of the Requirements for the Degree

MASTER OF SCIENCE IN MINING ENGINEERING

2013

Approved by

Dr. Stewart Gillies, Advisor
Dr. Jerry C. Tien
Dr. Kelly Homan

ABSTRACT

Booster fans are large underground fans that can increase the volumetric efficiency of ventilation systems by balancing the pressure and quantity distribution throughout a mine, reducing leakage and reducing the total power requirement.

The objective of this study is to provide potential users of booster fans with the necessary information on the design, installation and operation of main underground fans. The guidelines listed in this paper were formulated based on current U.S. and international standards, safe operating practices developed by the mining industry, and recommendations provided by fan manufacturers. The principles involved in the design and installation of booster fans are illustrated by a sample problem which is solved using a ventilation simulator in two configurations: a single-fan system and a two-fan system. The latter is used to highlight the benefits of using a booster fan system. This also illustrates some key design factors which, if not accounted for properly, may result in system inefficiencies and/or fan failures.

Booster fans are prohibited in underground coal mines in the United States. However, despite increased potential for recirculation, booster fans are used effectively in other major coal-producing countries such as Australia and the United Kingdom. Approaches specific to coal mine ventilation in other countries are compared to help identify practices that reduce risks associated with the use of booster fans. Two underground booster fans have been installed in the Missouri S&T Experimental Mine, an underground dolomite mine located in Rolla, Missouri.

Recirculation is a risk because it has the potential to increase the concentration of air contaminants, including methane, dust and heat in the intake air. Computational Fluid Dynamics (CFD) and Ventsim numerical models and experiments at the Missouri S&T Experimental Mine have been used to evaluate the effect of booster fan on recirculation, surface fan and the ventilation network.

ACKNOWLEDGMENTS

I would like to extend thanks to Dr. Stewart Gillies, my advisor, for his technical knowledge and constant encouragement. I also would like to thank Dr. Jerry Tien and Dr. Kelly Homan. Each member of my committee played an important role in my education. I also would like to thank Dr. Magesh Thiruvengadam for his assistance with the Computational Fluid Dynamics section.

I would like to further extend my appreciation to Missouri S&T Experimental Mine personnel, specifically Jimmie Taylor, and the Rock Mechanics and Explosives Research Center staff for their patience and cooperation. It was a great pleasure working with Michael Bassett, John Tyler and all others during my final semester. I also would like to extend my thanks to Diane Henke, Leanne Nuckolls, Shirley Hall, Barbara Robertson and Judy Russell for their patience and administrative support. I also would like to thank my fellow graduate students Xichen Zhang and Liang Wang for helping me conduct the surveys at the Experimental Mine.

I would like to show my appreciation to the National Institute for Occupational Safety and Health (NIOSH) for funding my research and education. I also would like to thank Mr. Trent Spendrup for his considerable donation in the purchase of two booster fans for Missouri S&T.

I would like to express my deepest appreciation to my parents, Latif and Dokhi, for their constant love, support and guidance. My abundant thankfulness to my uncle Dr. Javad Habibi and his wife, Dr. Monir Shababi, for their guidance and advice that I undertake graduate study. I would never have started graduate school without their influence. Finally I would like to express my thanks to my brother Aydin and his wife, Zahra, and my cousins Shay and Linda Habibi for their constant encouragement, support and for being my best friends.

TABLE OF CONTENTS

	Page
ABSTRACT.....	iii
ACKNOWLEDGMENTS.....	iv
LIST OF ILLUSTRATIONS.....	x
LIST OF TABLES	xiii
SECTION	
1. INTRODUCTION.....	1
1.1. PROBLEM STATEMENT	1
1.2. ANALYSIS TECHNIQUES.....	2
1.2.1. Network Modeling Using Ventilation Software.....	2
1.2.2. Experimental and Numerical Modeling Analysis (CFD).....	3
2. LITERATURE REVIEW	4
2.1. UTILIZATION OF BOOSTER FANS.....	4
2.1.1. Booster Fan Background in U.S.	4
2.1.2. Booster Fan Usage in the World.....	4
2.1.3. Australian and UK Survey.....	6
2.1.4. Utilization of Modern Booster Fans.....	6
2.2. ISSUES WITH BOOSTER FANS.....	8
2.2.1. Guidelines for Installing, Operating and Monitoring Booster Fans.....	8
2.2.2. Considerations for Utilizing Booster Fans in Underground Coal Mines.	10
3. BASIC EQUATIONS AND VENTILATION SURVEY	14
3.1. BASIC EQUATIONS.....	14

3.1.1. Atkinson's Equation.....	15
3.1.2. Kirchhoff's Laws.	16
3.2. SHOCK LOSS	17
3.3. FIELD SURVEY.....	21
3.3.1. Ventilation Survey.	21
3.3.2. Pressure Survey.	23
3.3.3. Air Quantity Survey.....	24
3.3.4. Fan Measurement Techniques.	25
3.3.5. Multiple Measurements.....	26
3.3.6. Entrance Length.....	27
3.3.7. Measuring the Pressure Difference over Stoppings and Doors.	28
4. USE OF UNDERGROUND BOOSTER FANS IN AUSTRALIA AND THE UNITED KINGDOM	31
4.1. INTRODUCTION.....	31
4.1.1. Australian Survey.	31
4.1.2. United Kingdom Survey.....	34
5. UNDERGROUND COAL MINE VENTILATION NETWORK BEHAVIOUR AND OPTIMIZATION WITH BOOSTER FANS.....	39
5.1. INTRODUCTION.....	39
5.2. MINE GENERAL INFORMATION	39
5.3. ASSUMPTIONS AND VENTILATION MODEL PREPARATION	42
5.3.1. Airflow and Contaminant Simulations.....	43
5.3.2. Cost Study Analysis.....	44
5.3.3. Cost Study.	44
5.3.4. Capital Cost of Fans.....	45
5.3.5. Capital Cost of Shaft.....	45

5.4. SIMULATION ALTERNATIVES	45
5.4.1. Scenario 1.....	45
5.4.2. Scenario 2.....	46
5.4.3. Scenario 3.....	49
5.4.4. Scenario 4.	50
5.4.5. Scenario 5.....	51
5.4.6. Scenario 6.	53
5.4.7. Scenario 7.....	56
5.5. SIMULATION RESULTS	57
5.6. CONCLUSION OF THE SECTION.....	58
6. MISSOURI S&T EXPERIMENTAL MINE.....	60
6.1. MINE DESCRIPTION	60
6.2. RISK ANALYSIS AND SAFETY CONSIDERATIONS	60
6.3. BASICS OF SYSTEM SAFETY	62
6.3.1. Risk Review Procedure.....	63
6.3.2. Hazard Identification.....	63
6.3.3. Risk Assessment.....	63
6.4. VENTSIM SIMULATION.....	72
6.4.1. Ventilation Path Description.....	73
6.4.2. Model Calibration.....	74
6.4.3. Booster Fans Selection.....	80
6.4.4. Simulation Results.....	83
6.5. CONCLUSIONS TO THE SECTION	84
7. BOOSTER FAN EXPERIMENTS AT MISSOURI S&T MINE	89
7.1. BOOSTER FAN INSTALLATION.....	89

7.1.1. Standard Booster Fan Installation.....	89
7.1.2. Mechanical Site Preparation.....	89
7.1.3. Booster Fans Transportation.....	89
7.1.4. Bulkhead Construction.....	95
7.1.5. Electrical Circuit Description.....	101
8. COMPUTATIONAL FLUID DYNAMICS (CFD) MODEL.....	105
8.1. INTRODUCTION.....	105
8.2. PROBLEM STATEMENT.....	105
8.3. THEORY OF THE AIRFLOW MODEL.....	107
8.3.1. Modeling Turbulence.....	107
8.3.2. Standard k-ε Model.....	107
8.4. SIMULATION METHODOLOGY.....	107
8.4.1. Introduction.....	107
8.4.2. Geometry Modeling and Mesh Generation (Pre-processing).....	108
8.5. GOVERNING EQUATION AND SOLUTION PROCEDURE.....	112
8.5.1. CFD Simulation (Solving Process).....	112
8.5.2. Governing Equations.....	112
8.5.3. Boundary Conditions.....	115
8.5.4. Solution Method.....	117
8.5.5. Analysis (Post Processing).....	118
8.6. RESULTS AND DISCUSSION.....	118
8.6.1. Scenario 1 (Booster Fan Excluded).....	119
8.6.2. Scenario 2 (Booster Fan).....	123
8.7. CONCLUSION OF SECTION.....	128
9. CONCLUSIONS.....	130

BIBLIOGRAPHY.....133

VITA136

LIST OF ILLUSTRATIONS

	Page
Figure 3.1 Character of the flow in 90 degree bend and the associated loss coefficient.....	19
Figure 3.2. Character of flow in a 90 degree elbow and associated loss coefficient	20
Figure 3.3. Side view of an elbow	21
Figure 3.4. Measuring positions for circular ducts	26
Figure 3.5. Developing velocity profile and pressure changes in the entrance of duct flow (White, 2007)	27
Figure 3.6. USBM method of measuring single stopping leakage and resistance (After Vinson, 1977; from Oswald, 2008)	29
Figure 3.7. Measuring leakage at Missouri S&T Experimental Mine stopping	30
Figure 5.1. Ventsim Visual, schematic view of expanded model	40
Figure 5.2. View of ventilation infrastructure.....	41
Figure 5.3. Ventsim Visual schematic view of intake shaft #2.....	48
Figure 5.4. Ventsim Visual schematic view of exhaust shaft #2	51
Figure 5.5. Stalled fans characteristics curve and operating point	52
Figure 5.6. Booster fan #2 characteristics curve, 1st main east	54
Figure 5.7. Booster fan #1 characteristics curve, 2nd main west	54
Figure 5.8. Booster fan locations	55
Figure 6.1. The Missouri S&T Experimental Mine portals	61
Figure 6.2. Main fan infrastructure at Experimental Mine	61
Figure 6.3. Experimental Mine elbow	62
Figure 6.4. Ventsim schematic view of Missouri S&T Experimental Mine	73

Figure 6.5. Kennedy portal	74
Figure 6.6. Wheeler portal.....	75
Figure 6.7. Ventilation stations at Experimental Mine.....	76
Figure 6.8. Shock loss at Experimental Mine model	80
Figure 6.9. Fan characteristics curve.....	82
Figure 7.1. Installation booster fans (Calizaya, 2009).....	90
Figure 7.2. Channel iron runners	90
Figure 7.3. Box cross member	91
Figure 7.4. View of the skid	91
Figure 7.5. Side rails with D lashing rings	92
Figure 7.6. Completed skid with the mounted booster fan	93
Figure 7.7. Removable lifting axle assembly	94
Figure 7.8. Booster fan transportation	95
Figure 7.9. East booster fan location preparation.....	96
Figure 7.10. Anchoring the frame to the back of the mine	97
Figure 7.11. Steel plate attached to frame pieces	98
Figure 7.12. Blocking the area around the booster fan with 20mm plywood	99
Figure 7.13. Completed bulkhead view	100
Figure 7.14. Missouri S&T Experimental Mine electrical circuit plan.....	101
Figure 7.15. Surface preparation to pass the power cable underground.....	102
Figure 7.16. The underground safety switch	103
Figure 7.17. Electrical components at the West booster fan	104
Figure 7.18. East booster fan installed in bulkhead	104

Figure 8.1. CFD model schematic view.....	109
Figure 8.2. Tetrahedral mesh generation of booster fan.....	110
Figure 8.3. Mesh generation at Kennedy portal.....	110
Figure 8.4. Mesh generation at stopping region.....	111
Figure 8.5. Velocity pathlines distribution.....	120
Figure 8.6. Total pressure distribution contours.....	120
Figure 8.7. Pressure gradient without booster fan.....	121
Figure 8.8. Velocity vectors through stoppings and doors.....	122
Figure 8.9. Velocity pathlines across the domain.....	124
Figure 8.10. Pressure distribution contours across the domain.....	125
Figure 8.11. The created planes across the models.....	125
Figure 8.12. Area-weighted average total pressure downstream to the booster fan.....	126
Figure 8.13. Pressure gradient with the presence of booster fan.....	127
Figure 8.14. The velocity magnitude vectors at leakage regions.....	128

LIST OF TABLES

	Page
Table 4.1. Summary of Australian underground coal mine survey	32
Table 4.2 Summary for United Kingdom underground coal mine survey.....	35
Table 5.1. Scenario 1 predicted airflows on working faces	46
Table 5.2. Scenario 2 predicted airflows on working faces	47
Table 5.3. Scenario 3 predicted airflows on working faces	49
Table 5.4. Scenario 4 predicted airflows on working faces	50
Table 5.5. Scenario 5 predicted airflows on working faces	52
Table 5.6. Scenario 6 predicted airflows on working faces	55
Table 5.7. Scenario 7 predicted airflows on working faces	56
Table 5.8. Contaminant and airflow simulation results	57
Table 6.1. Possible environmental consequences.....	64
Table 6.2. Risk analysis probabilities	65
Table 6.3. Risk analysis matrix.....	65
Table 6.4. Risk assessment analysis results at Missouri S&T Experimental Mine	66
Table 6.5. Ventilation survey results, both booster fans excluded	77
Table 6.6. The comparison of predicted Ventsim Visual and experiments results	78
Table 6.7. Ventsim results for different fan alternatives	85
Table 6.8. Scenario 2, experimental and Ventsim Visual results.....	86
Table 6.9. Scenario 3, experimental and Ventsim Visual results.....	87
Table 6.10. Scenario 4, experimental and Ventsim Visual results	88
Table 8.1. Grid independent study.....	112

Table 8.2. Comparison of experimental and CFD simulation results	119
Table 8.3. Comparison of CFD simulation and experimental results (with booster fan).....	123

1. INTRODUCTION

1.1. PROBLEM STATEMENT

A booster fan is an underground fan installed in series with a main surface fan and used to boost the air pressure of the ventilation air passing through it. Currently booster fans are used in almost all foreign major coal mining countries requiring this form of ventilating air motivation including the United Kingdom, Australia, Poland, South Africa and China. In the United States they are used in a significant number of metal and non-metal mines, however, due to concerns of uncontrolled recirculation, coal mine operators have not been allowed to use them.

The use of booster fans to assist in the ventilation of either individual mine sections or in the Mains to assist the entire mine is not common in coal mines due, normally, to the ease of installing additional shafts or larger surface fans compared to the operational problems and cost associated with installation of underground booster fans. However, with significant increases in volumetric requirements at higher production rates, increase in block geometry and depth of workings together with mines being developed under environmentally-sensitive areas, booster fans become a more attractive and economically viable solution.

There are two major hazards associated with the misuse of booster fans: mine fires and flow recirculation. This study has developed information about these hazards, recommended control measures, and action plans to prevent them.

The use of underground booster fans is one method of increasing the effectiveness of a ventilation system. Booster fans can reduce ventilation costs and increase the system efficiency in comparison with other approaches by reducing the required main fan pressure and by decreasing system leakage.

Booster fan systems are used commonly in underground coal mines in the United Kingdom, Australia, and other coal producing countries and these systems are considered safe, reliable, and essential. Although booster fans are used regularly in other countries, they are

prohibited in all non-anthracite underground coal mines in the United States (30 CFR § 75.302 2010).

1.2. ANALYSIS TECHNIQUES

Many ventilation systems that use booster fans experience a significant amount of recirculation. Most underground coal mines in the United Kingdom rely on booster fans and recirculation to provide adequate air quantities and velocities. Methods to limit recirculation in ventilation systems using booster fans need to be evaluated.

Research defining how system pressure, air power, and quantity are affected by booster fans; describing how system efficiency and recirculation are affected by the location, placement, and size of the booster fans; and identifying the relationships between booster fans and main surface fans in ventilation systems that are consistent with U.S. mining conventions is presented in this study.

1.2.1. Network Modeling Using Ventilation Software. Numerical Modeling software (Ventsim) has been used to evaluate the efficiency of booster fans within a mine ventilation system. As part of this study the ventilation model has been expanded for the next five years and simulations have been conducted to quantify the effect of the booster fan on operating costs.

In addition, a cost study analysis has been done to evaluate the optimal solution for the future of the ventilation plan. Two underground booster fans have been installed at Missouri S&T's Experimental Mine to demonstrate that system recirculation, one of the primary risks associated with the use of booster fans, can be controlled by adequately sizing and positioning of booster fans. Pressure and quantity surveys have been conducted and a ventilation model has been created. Additional tests have been conducted to investigate the effects of main fan pressure and booster fan pressure on system leakage and system recirculation based on studies of a scaled coal mine model are presented.

1.2.2. Experimental and Numerical Modeling Analysis (CFD).

Computational fluid dynamics (CFD) models have been used to demonstrate how recirculation occurs across the stoppings and how the system efficiency is affected by utilizing a booster fan.

2. LITERATURE REVIEW

2.1. UTILIZATION OF BOOSTER FANS

2.1.1. Booster Fan Background in U.S. In the U.S., the approach to mine design under inspection rules is highly prescriptive and the use of booster fans in coal mines is prohibited based on a fear that the operation of a booster fan installation could not be adequately controlled from outside the mine and could lead to abnormal recirculation conditions or other potential hazardous situations (Kennedy, 1999). It is in this context that the banning of their use in U.S. coal mines is being examined. It can be concluded that the U.S. has fallen behind similar coal mining countries in adopting risk-management-based safety approaches. As such, there is hesitancy by inspectorial groups federally and within the individual states to allow use of complex systems such as booster fans as they do not easily lend themselves to regulation through prescriptive systems. Rather, complex booster fan systems require “ownership” for safety systems to be accepted by mine managers through a risk management approach (Gillies, 2011).

2.1.2. Booster Fan Usage in the World. The use of booster fans in underground mines can be divided into three categories: fans in the Mains returns, fans in the panel returns, and fans that allow for recirculation of uncontaminated return air into the intake. Of the systems studied, the most prevalent is the use of booster fans in the Mains returns.

The installation of booster fans in the Mains returns of coal mines poses several unique challenges. The first and foremost is installing fans in such a way that methane in the returns does not pose an explosion hazard. The simplest solution would be to install the fan with an explosion-proof motor. This, however, is not an optimal solution due to the cost of the motors. Another solution would be to situate the fans such that a system of belts and drive shafts will be used to transfer power from the motor located in the intake airway to the fan located in the return entries.

Currently booster fans are used in mines in almost all major foreign coal mining countries requiring this form of ventilating air motivation including the United Kingdom, Australia, Poland,

South Africa and China. In the United States booster fans are prohibited in coal mines, although they are used in many metal and non-metal mines.

One primary example of this system was the North Goonyella Colliery's system (R L Burnett and D Mitchell, 1988). This system, now not needed due to the progression of the mine, was placed in the three primary mainstream return air headings of the mine. The fans were installed in bulkheads in two of the return entries with a bypass door installed in the center entry. The drive shafts were run through the bulkheads in the crosscuts next to the fans so that the motors could be installed in areas of intake air.

The other solution to the problem of methane ignition would be the use of non-sparking motors that are either flameproof electrical design, compressed air driven or hydraulically driven.

The use of booster fans to assist in panel ventilation is less widespread. The only examples found were in coal mines in the United Kingdom where booster fans are quite common and used in nearly all underground mines. In principle, these installations are similar to installations in the Mains with the fans situated in the return airways and the motors placed on the other side of the bulkheads in the intake airways.

The final example of booster fan installations are those that are seen in controlled recirculation. The primary examples of this method are in collieries in the United Kingdom. While generally prohibited, this practice has been allowed on a case-by-case basis. These systems are used in mines where the surface fan can meet the statutory ventilation requirements, the mine is non-gassy and additional airflow is desired at the face to reduce dust, heat or other environmental nuisances. These systems are primarily located in a small drift driven next to the intake that is connected through a series of overcasts to the primary exhaust airways.

Monitoring is done both in the return before the recirculation split as well as after the recirculation split in the intake. The monitoring systems are preset so that if methane or carbon monoxide levels increase in the recirculation split the recirculation fan will shut down automatically.

2.1.3. Australian and UK Survey. A detailed study has been undertaken by Gillies and Calazaya, 2012, of the usage of booster fans in three coal mines each in Australia and the United Kingdom. The study focused on issues in each mine such as the need for use of booster fans rather than use of additional surface fans, use of gas and airflow quantity and pressure monitoring, potential for air recirculation, stopping leakage, lock out systems in use to handle the situation when some mine fans fail, and economic considerations. Regulations or procedures in use and the views of mine inspectors have been sought. The approaches in use in Australia and the United Kingdom have been compared in a general way with the situation pertaining in the United States (Gillies and Calizaya, 2012).

2.1.4. Utilization of Modern Booster Fans. The utilization of modern booster fans started in the United Kingdom in the early 1900s when it was reported that booster fans were used to ventilate three separate coal seams at the Hulton Colliery. The UK Coal Mine Act of 1911 allowed British coal mines to use booster fans provided that there was a main fan on the surface.

As a result many underground booster fans were installed and work conditions improved substantially. This was demonstrated by a drop in British fatal explosions from 23 in 1911 to six in 1919 (Saxton, 1986). A review of the current literature in mine ventilation shows numerous examples of the utilization of booster fans in the UK. Burnett and Mitchell (1988) is one such example.

In Australia, booster fans are used in the two coal mining states of New South Wales (NSW) and Queensland. The practice of using underground booster fans is quite common in Australian metal mines but their use in modern collieries has been very limited. The Darkes Forest Colliery in NSW made use of an underground booster fan installation in the 1970s.

New applications have occurred in Australian coal mines with installation of booster fans utilized in Australian mines as an integral part of the mine ventilation system. Two coal mines have more eight years of recent booster fan usage experience each, although one of these was decommissioned in 2009 due to the availability of air from a new shaft. A third mine under

sensitive forest land recently installed a single booster fan in October 2011, while a fourth is seriously considering an installation due to requirements for dilution of high gas levels. Other booster fan installations are under serious consideration in Australia.

Booster fans have been common in use on the continent in Europe, particularly in the working of very deep coal seams. Their use has been significant in multi-seam extraction mines with deep and gassy workings such as those found in Poland.

This study on use in Australia and the United Kingdom has been examining booster fan usage in coal mines and approaches against a background of the situation pertaining in the United States. As described by Lauriski and Yang, 2011 U.S. mine safety regulations have always been prescriptive but have become increasingly so in response to the Sago Mine multi-fatality accident of January 2006. Since then the U.S. Mine Safety and Health Administration budget, numbers of citations, and assessed penalties for violations have increased dramatically but catastrophic accidents continue to occur. They raise the question of why other countries such as Australia, the United Kingdom and South Africa with large modern coal mining industries have achieved better mine safety performances than the U.S.

Traditionally, Australian mining regulations were also prescriptive. However since the 1990s these have shifted to performance and/or risk-based measures with the passing of new legislation in the two main states of New South Wales and Queensland. The new legislation is outcome based and embraces the concept of system-based standards that incorporate principles of risk management. Instead of prescriptive, or specification, standards, which tell employers precisely what measures to take, which technologies to use and allow little interpretation,

Australia's current safety approaches impose general obligations that require mining industry employers to establish internal health and safety management systems and to continue managing risks as long as it is reasonably "practicable". There are requirements to establish principal hazard management plans for specific hazards that include, among others, strata failure, in-rush, fire and explosions, dust explosions, explosives and airborne dust. Plans required of the

mine operator must include standard operating procedures, measures to control risks, triggers of actions and responsibilities. The change of approach in Australia has had a dramatic impact on safety performance.

It is of interest that Australia, the United Kingdom and South Africa have been leaders within the international mining industries to adopting systems of safety risk management. The onus for responsibility is placed on the mine operator who must prove he is aware of requirements to achieve operational behaviour at a standard of world's best practice and accept responsibility. Potential hazards that may occur in use of booster fan systems must be assessed under risk management procedures. Systems are not prescriptive but the onus of responsibility requires that all safety issues in a particular situation must be assessed and written safety systems utilized.

2.2. ISSUES WITH BOOSTER FANS

2.2.1. Guidelines for Installing, Operating and Monitoring Booster Fans.

Great care is usually given in the mining industry to design and installation of main fan assemblages, but less to the installation of underground booster fans. The proper design of the primary ventilation fans is critical to a mine. However, as mines mature and rely more heavily on booster systems to redistribute the airflow and help the main surface fans, the more important proper design and implementation of booster fans becomes (Krog R.B, 2002).

There are certain ways to install underground booster fans. Some booster fans are installed without considering the large impact that shock loss can cause. Fan curves are predominantly created with one or both ends of the fan attached to ducting or exhaust cones. Underground booster fans mounted directly to bulkheads have a very high shock loss that is not incorporated in the fan curve. Underground booster fan curves usually have to undergo major alterations to achieve accurate results. Misinterpretation of fan curves and misapplication of a

simplified ventilation model usually results in an underestimation of booster fan's shock losses when applied to a real world condition.

A booster fan, properly sized and sited, can be used to create safe work conditions and allow the extraction of minerals from areas that would otherwise be uneconomic to mine. In deep and large mines with heavy emissions of air contaminants, the required quantities of air can only be supplied by using high pressure fans. These fans will inevitably induce significant leakage losses of fresh air through stoppings and doors. For well-defined ventilation circuits, booster fans can be used to decrease the main fan pressures and reduce the leakage flows (Calizaya, 2009). Some optimization programs have been developed to determine fan duties (Moll, 1994), however they do not check the recirculation for the network (Calizaya, 1987).

Before any booster fan installation is considered, alternate options should be evaluated carefully. Options such as upgrading the main fan, repairing damaged bulkheads, and slashing high resistance airways should be considered first, then the possibility of using booster fans. Planning for the usage of booster fans in existing mines almost always starts with ventilation surveys and estimation of airflow requirements. This is followed by network modeling and simulation exercises for different ventilation strategies (Calizaya, 2009).

The installation process may require the development of a bypass drift, widening of an existing drift, installation of airlock doors, and miscellaneous civil constructions. The drifts should be widened as recommended by the fan manufacturer. They should provide ample space to house the fan assembly, an overhead monorail, man doors and fan condition monitoring components. The fan installation usually starts with the construction of concrete foundations. This is followed with the installation of an overhead monorail, the installation of fan housing and the construction of a bulkhead. The job is completed with the installation of airlock doors and a pre-fabricated fixture between the diffuser and the bulkhead. The next task is fan testing and commissioning. Testing involves checking the fan for stability, and running it first at no load (with the airlock doors open), and then at full load (with the doors closed). Parameters such as

vibration, bearing temperatures, shaft alignment, and blade tip clearance, are measured during each test. These values are then compared against standards and pre-established limits. In most cases, the measured parameters are evaluated against the following limit values (alarm levels) (Calizaya, 2009):

- Vibration: 0.05 mm/s
- Motor temperature: 85 °C
- Shaft alignment: 0.05 mm
- Fan duty: $\pm 5\%$ of designed values.

A monitoring system is a basic requirement in the operation of booster fans. To prevent the recirculation of air contaminants (mine gases or combustion products), the system should include sensors to measure (Robinson, 1989) carbon monoxide and methane concentration and air velocity. In addition fan vibration and motor current and input power should be monitored.

2.2.2. Considerations for Utilizing Booster Fans in Underground Coal Mines.

A booster fan is an underground ventilation device installed in the main airstream (intake or return) to handle the quantity of air circulated by one or more working districts (McPherson, 1993). There are two major hazards associated with the misuse of booster fans: mine fires and flow recirculation. These guidelines provide information about these hazards, recommended control measures, and action plans to prevent them.

Leakage is a loss of air from one airway to another, normally from intake to return. For any mine layout, leakage may occur through bulkheads, doors, overcasts, and mined-out areas. The higher the pressure across these structures, the higher the leakage.

Recirculation is the process of reusing part of the return air to ventilate a working district. There are two types of recirculation: controlled recirculation and uncontrolled recirculation.

In the former, a fraction of the return air is conditioned (filtered or mixed) and intentionally directed to a working district. This assists the main fan in controlling the air

contaminants. In the latter, part of the contaminated air is sent back to the face through stoppings and doors in an uncontrolled manner. This condition is created when the booster fan is oversized or when it is allowed to run while the main fan is stopped. Uncontrolled recirculation exposes mine workers to unsafe conditions and must be avoided (Calizaya, 2009).

Some of the possible advantages of booster fans identified are:

- reduced intake to return pressure differentials and hence reduced leakage and need for airlocks;
- reduced surface fan pressures, allowing existing installations to remain in place;
- as an alternative to avoid potentially more expensive options such as shafts, additional headings or prohibitively large surface fans; and
- as a method to be used to boost single panel(s) rather than the whole mine to minimise regulation and hence mine resistance.

Use of booster fans can lead to lower operating electricity power costs as they augment mine fan power and do not destroy energy as occurs with use of mine regulators. As such, they are a better alternative approach to balancing or controlling airflow through mine parallel splits. They may extend life of mine fan duty as they augment mine fan power. Their introduction allows deferral of installation of a new ventilation shaft or other major capital facility.

However there are various disadvantages of booster fans (Gillies, 2010):

- Capital cost of booster fans will certainly be greater than cost of regulator installation.
- Monitoring of their off/on status is required particularly in gassy atmospheres. Automatic shut-off is required if the main fans stop to avoid underground recirculation.
- Shut off of either main surface or booster fans can trigger a requirement of withdrawal of all miners to the surface whether the shut off is caused by an electronic fault or a serious system failure.

- Their use in a gassy atmosphere may require flame-proof electrical components or placement of electric motors in intake air. This may necessitate use of extended drive shafts from intake to return air sides of a bulkhead.
- If used in a gassy atmosphere the fan must be designed with anti-sparking characteristics. This means using stainless steel rotor and blades and also means that the most commonly used axial fan impeller material, aluminum, cannot be used.
- The layout of parallel intake and return airways in collieries does not usually lend itself to the use of boosters. Most colliery panels comprise multiple intake airways and multiple returns in parallel. If one fan is used all return air to be boosted must be directed to one single airway.
- Colliery roadways are usually wide openings with limited vertical dimensions. This shape does not lend itself to the accommodation of a large fan and therefore, a considerable amount of site preparation and removal of roof material is usually required.
- Competent stoppings are required where high air pressures occur downstream of fans to reduce leakage of return air into intakes and avoid recirculating flows.
- In the event of some emergency situations such as an underground fire or serious roof fall, it may become critical to control the fan. This requires remote surface control equipment. There must also be proper warning devices on the surface to indicate a stoppage of the booster fan.

The installation of booster fans in the main returns of coal mines poses several unique challenges. The first and most important is installing fans in such a way that methane in the returns does not pose an explosion hazard. The simplest solution would be to install the fan with an explosion-proof motor. This, however, is normally not an optimal solution due to the cost of the motors.

Another solution would be to situate the fans such that a system of belts and drive shafts will be used to transfer power from the motor located in the intake airway to the fan located in the return entries (Gillies, 2010).

The use of booster fans to assist in panel ventilation is less widespread. Only one coal example is known from the literature (Ashelford, 2009); however in metal and non-metal mines booster fans are quite common. In general these installations are similar to installations in the Mains with the fans situated in the return airways and the motors placed on the other side of the bulkheads in the intake airways.

The final example of booster fan installations are those that are seen in controlled recirculation. The primary examples of this method are in collieries in Britain. While generally prohibited, this practice has been allowed on a case-by-case basis. These systems are used in mines where the surface fan can meet the statutory ventilation requirements, the mine is non-gassy and additional airflow is desired at the face to reduce dust, heat or other environmental nuisances. These systems are primarily located in a small drift driven next to the intake that is connected through a series of overcasts to the primary exhaust airways (Gillies, 2010).

At a point in the mine's life where the main fans are operating close to their stall point or an unstable region of the operating curve several options must be considered to prolong the operation's life or provide the option to extend workings into new areas. This includes consideration of the ability to increase the duty of the main fan installation. Booster fans can be considered and have in reality been used to extend the life of longwall operations as exemplified in the British longwall mining industry (Jobling et al., 2001).

3. BASIC EQUATIONS AND VENTILATION SURVEY

3.1. BASIC EQUATIONS

The principal process of total air conditioning concerned with control of air circulation is ventilation. Mine ventilation is normally an example of a steady-state process, that is, one in which none of the variables of flow changes with time.

Transitions and losses in energy are involved in such a process. The total energy at any section in a moving fluid consists of the sum of internal, static, velocity, potential and heat energies at that section (Hartman, 1997).

$$H_t = H_s + H_v \quad (3.1)$$

Where

H_s = static head (m)

H_v = velocity head (m)

When the air travels in a vertical direction the thermodynamics laws must be applied. Since the heat energy is neglected, the total energy could be calculated from the Bernoulli equation for incompressible fluid:

$$\left(\frac{P_1}{\gamma}\right) + \left(\frac{V_1^2}{2g}\right) + z_1 = \left(\frac{P_2}{\gamma}\right) + \left(\frac{V_2^2}{2g}\right) + H_L \quad (3.2)$$

Where

P = absolute air pressure (Pa)

V = air velocity (m/s)

γ = specific weight of the air (kg/m^3)

Z = elevation (m)

H_L = head loss (m)

3.1.1. Atkinson's Equation. The friction loss in a mine airway is a function of the velocity of flow, the interior surface characteristics and the dimensions of the airways. A loss in static pressure occurs as a result of the drag or resistance of the walls of the opening and the internal friction of the fluid itself (Hartman, 1997).

The equivalent length method permits the calculation of the overall head loss for a given airway considering air as of an incompressible fluid.

$$\Delta p = \frac{KO(L + L_e)Q^2}{A^3} \quad (3.3)$$

Where

Δp = pressure difference (Pa)

K = friction factor, (kg/m³)

O = perimeter, (m)

L = Length (m)

L_e = equivalent length for shock loss, (m)

Q = volumetric flow rate, (m³/s)

A = cross sectional area, (m²)

The velocity head represents kinetic energy that has to be supplied to maintain flow and is lost to the system at discharge. An equation for velocity head is as following:

$$H_v = \frac{\rho v^2}{2} \quad (3.4)$$

Where

H_v = velocity head (Pa)

ρ = fluid density (kg/m³)

V = velocity (m/s)

The resistance is directly proportional to airways length and inversely proportional to airways cross sectional area.

3.1.2. Kirchhoff's Laws. The fundamental laws governing the behavior of electrical circuits have been extensively applied in ventilation circuit analysis. According to Kirchhoff's first law also known as Kirchhoff current law (KCL), the quantity of air leaving a junction must equal the quantity of air entering a junction (Hartman, 1997). In other words, the conservation of mass equation must be satisfied. Therefore:

$$\sum Q = 0 \quad (3.5)$$

Where

Q = Volumetric flow rate, (m³/s)

Kirchhoff's second law, also known as Kirchhoff's voltage law (KVL) states the sum of the pressure drop (change) around any closed ventilation circuit must be zero. Natural ventilation pressure can work with the ventilation system as a positive or negative pressure source (McPherson, 1993). The Kirchhoff's second law can be written as (Wempen, 2012):

$$\sum p_i = p_f \pm p_n \quad (3.6)$$

Where:

p_i = pressure difference in ith branch of a closed circuit, (kPa)

p_f = pressure increase due to fan, (kPa)

p_n = natural ventilation pressure, (kPa)

3.2. SHOCK LOSS

These occur in mine ventilation systems in addition to friction losses and:

- Where airflow direction changes;
- Where airway area changes;
- Where there are obstructions in airways;
- Fan inlet/discharge;
- Air splits and junctions;
- Where two airways with different cross sectional

Two methods are used to calculate shock losses.

1. Direct calculation from velocity head

$$P_x = XP_v \quad (3.7)$$

Where

H_v is velocity pressure and X is a site dependent dimensionless shock loss factor.

Whenever the airflow is required to change direction, additional vortices will be initiated. The propagation of those large-scale eddies consumes mechanical energy (shock losses) and, hence, the resistance of the airway may increase significantly. This occurs at bends, junctions, changes in cross section, obstructions, regulators, and at points of entry or exit from the system.

The effects of shock losses remain the most uncertain of all the factors that affect airway resistance. This is because fairly minor modifications in geometry can cause significant changes in the generation of vortices and, hence, the airway resistance. Analytical techniques may be employed for simple and well defined geometries. For the more complex situations that arise in practice, scale models or computational fluid dynamics (CFD) simulations may be employed to investigate the flow patterns and shock losses. Shock losses are often referred to in terms of the

head loss or drop in total pressure, shock caused by the shock loss. This, in turn, is expressed in terms of 'velocity head'.

$$P_{shock} = X \rho \frac{v^2}{2} \quad (3.8)$$

Where

ρ = is air density, (kg/m³)

X = Shock loss factor

V = Velocity of air (m/s)

The shock loss factor can be converted into an Atkinson type of resistance, R_{shock} , by re-writing equation as a square law:

$$P_{shock} = X \rho \frac{Q^2}{2A^2} = R_{shock} Q^2 \quad (3.9)$$

Where

$$R_{shock} = \frac{X\rho}{2A^2} \quad \frac{Ns^2}{m^8} \quad (3.10)$$

If rational resistances (R_t) are employed then the density term is eliminated. The major cause of the additional resistance is the propagation of vortices downstream from the cause of the shock loss. Accordingly, in most cases, it is the downstream branch to which the shock resistance should be allocated.

The pressure loss of a contracting cross section can be significantly reduced. In elbows the airflows streamlines are curved and centrifugal forces cause a pressure increase near the outer wall of elbow. The pressure increases while the fluid enters the elbow.

The head loss in long, straight sections of airways can be calculated by use of the friction factor obtained from either the Moody chart or the Colebrook equation. Bends in airways and ducts produce a greater head loss than if the pipe were straight. The losses are due to the

separated region of flow near the inside of the bend (especially if the bend is sharp) and the swirling secondary flow that occurs because of the imbalance of centripetal forces as a result of the curvature of the pipe centerline. These effects and the associated values for large Reynolds number flows through a bend are shown in Figure. 3.1. The friction loss due to the axial length of the pipe bend must be calculated and added to that given by the loss coefficient (White, 2007).

For situations in which space is limited, a flow direction change is often accomplished by use of miter bends, as is shown in Figure. 3.2(a) and Figure 3.2(b) rather than smooth bends. The considerable losses in such bends can be reduced by the use of carefully designed guide vanes that help direct the flow with less unwanted swirl and disturbances.

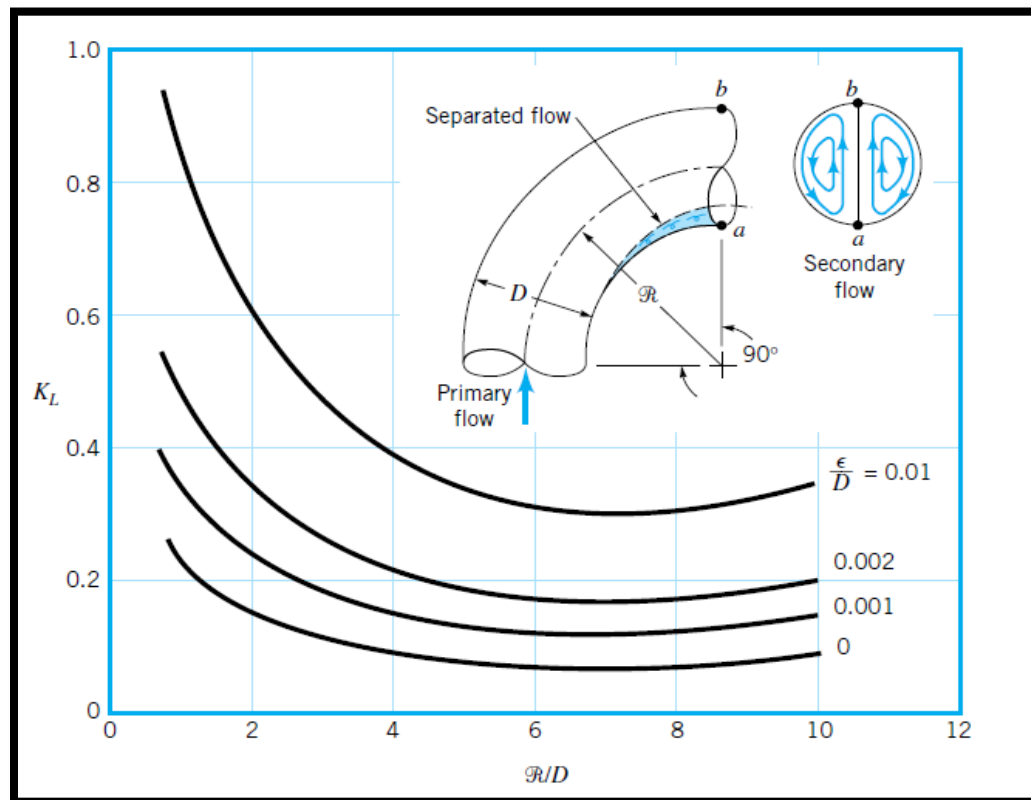

Figure 3.1 Character of the flow in 90 degree bend and the associated loss coefficient

At the inside of the elbow, the pressure decreases. This condition may lead to a separation and turbulence and corresponding losses in flow energy. The magnitude of these losses to a large extent depend on the sharpness of the curvature. The main portion of flow pressure losses in curved tubes is due to formation of eddies at the inner wall. Rounding of the elbow corners makes the flow separation smoother and consequently lowers the resistance. The minimum resistance is achieved when outer and inner radii are related as in Figure 3.3.

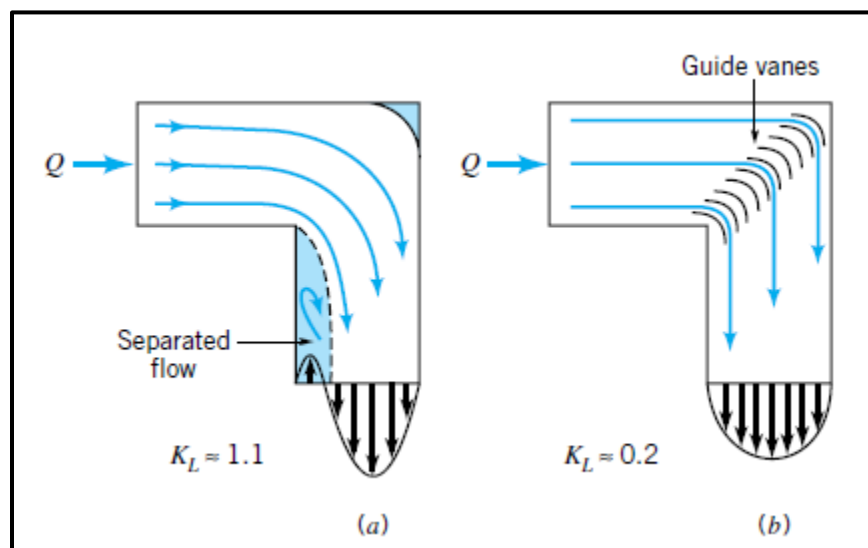

Figure 3.2. Character of flow in a 90 degree elbow and associated loss coefficient: (a) without guide vanes, (b) with guide vanes

$$\frac{r_1}{d_0} = \frac{r_0}{d_0} + 0.6 \quad (3.11)$$

The diameter of the Experimental Mine elbow is 94cm with the $r_0=38\text{cm}$ and $r_1= 47\text{cm}$.

substituting the measured values shows that the equation is not satisfied.

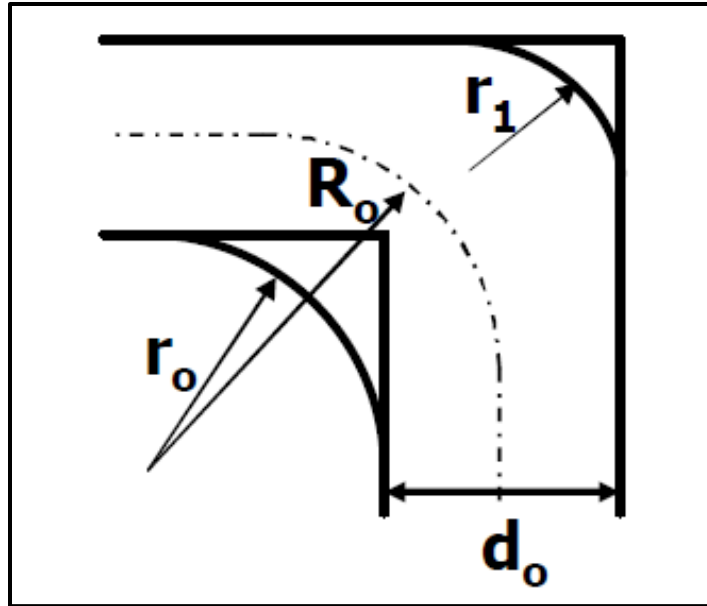

Figure 3.3. Side view of an elbow

3.3. FIELD SURVEY

The ventilation survey of the Missouri S&T Experimental Mine involved the determination of the airflow and differential pressure distribution as well as the quantification of the fan operating pressures. Airflow quantities have been determined by conducting full section vane anemometer traverses and multiplying by a measured cross sectional area. For increased accuracy six readings have been taken at each ventilation station to calculate the cross sectional area. To take the effect of natural ventilation pressure into account, the dry bulb temperature, wet bulb temperatures, and barometric pressure have also been measured at selected ventilation stations throughout the mine.

3.3.1. Ventilation Survey. Analysis of an existing mine ventilation system, including the evaluation of modifications to the system, requires accurate input data that can be developed only by a data pressure-quantity survey in the mine (McElroy and Kingery, 1957). The

purposes of an accurate underground pressure survey are to obtain a pressure gradient along the circuit and determine the values of friction factor for various types of airways.

A ventilation survey is an organized procedure of acquiring data that quantify the distributions of airflow, pressure and air quality throughout the main flow paths of a ventilation system. That requires detail and precision of measurement.

As mentioned previously, mine pressure and quantity surveys are undertaken to gain an understanding of mine characteristics in total and in particular airflow characteristics through sections of a mine. Complete ventilation surveys are performed periodically or at random times for the following reasons:

- to obtain knowledge of the extent and adequacy of the existing ventilation system in meeting specific needs, standards and regulations.
- to provide information for use in emergencies or disasters underground, such as fires, explosions, major cave-ins or floods.
- to plan for improvement of current environmental conditions or efficiency of existing ventilation system.
- to make provisions for mining extension or modifications, new fan installations, changes in airways or circuits, and the installation of new airshafts.

Pressure survey data is required in particular:

- to enable modification and expansion of ventilation circuits to be planned.
- to isolate critical zones of high pressure loss and high friction factor to enable improvement in network efficiency.

To enable a realistic pressure and quantity profile for a mine to be obtained, conditions under which airflow fluctuations are at a minimum should be sought. In particular surveys should be undertaken with minimum activity in the mine, preferably on a non-working shift. Mine resistance is affected by:

- vehicle movement
- falling water in upcast shafts
- opening of mine doors
- leakage through overcasts
- man movement
- fan fluctuations particularly if near stall region
- changes in NVP and abrupt climatic changes in general

3.3.2. Pressure Survey. Pressure measurements in underground mines can be made on either an absolute or differential basis. Measurements made on an absolute basis at each station are subtracted one from the other to find the pressure loss between stations. For the purpose of this study the differential pressure measurement method has been used. In this method a precision pressure sensors is to be used to measure the difference between the pressures applied to two different stations.

There are two methods of conducting pressure surveys:

- Direct method: Rubber tubing or hose is laid between the two points between which pressure difference is to be measured. A precision pressure sensor is then connected either at one end or at some other convenient point along the tube. The manometer reading is the pressure difference between the two points.
- Indirect Method: uses a pair of precision pressure sensors which are used for obtaining the pressure difference between any two points in an airway. Since they indicate only the absolute static pressure at a point, the difference in pressure must be calculated from adjacent readings rather than read directly.

In conducting a survey using indirect method, either of two methods may be used, both requiring two instruments. The first method is called the *leapfrogging method* where both instruments are taken underground and read simultaneously at adjacent stations. The preceding

instrument is the advancing instrument for each successive measurement. Both instruments are adjusted to the same reading at each station, and with simultaneous readings with the aid of synchronized watches, the effect of atmospheric-pressure changes is eliminated. Since readings at each station are also duplicated, the results are more accurate.

The second method is the *single-base method* where one instrument is used underground in making the traverse while the second one remains on the surface or at some base point underground. Readings at both are taken on a prearranged time schedule. A recording precision pressure sensor can also be used for the base instrument. Three corrections to altimeter data (atmospheric pressure changes, velocity differences, and elevation differences) are necessary to calculate the pressure (SME Handbook, 1992).

Two velocity readings have been taken at each ventilation station and evaluated for consistency. Readings deviating more than 1.0 Pa from each other have been repeated. At junctions and splits, readings have been taken to ensure the fulfillment of the Kirchhoff's First Law (the sum of the airflow entering a junction equals the sum of the airflow exiting a junction). In order to calculate the airway resistance accurately, pressure readings have been taken approximately at the same time as airflow readings.

The measured readings have been analyzed and later inputted into the software program. The total intake and exhaust air quantity balance have been compared. The error between intake and exhaust airflows is due to the turbulence around the base of the intake shaft and leakage through the surface elbow.

3.3.3. Air Quantity Survey. The vast majority of air velocity measurements made manually underground are gained from a rotating vane (windmill type) anemometer. When held in a moving airstream, the air passing through the instrument exerts a force on the angled vanes, causing them to rotate with an angular velocity that is closely proportional to the airspeed. A gearing mechanism and clutch arrangement couple the vanes either to a pointer which rotates against a circular dial calibrated in meters or to a digital counter.

The anemometer should be attached to a rod of at least 1.5m in length, or greater for high airways. The attachment mechanism should permit the options of allowing the anemometer to hang vertically or to be fixed at a constant angle with respect to the rod.

An anemometer is fairly insensitive to yaw and will give results that do not vary by more than ± 5 percent for angles deviating by up to 30° from the direction of the airstream.

For precise work, anemometer readings may be further corrected for variations in air density:

$$u = u_i + C_c \sqrt{\frac{\rho_c}{\rho_m}} \quad (3.12)$$

Where

u = corrected velocity

u_i = indicated velocity

C_c = correction from instrument calibration curve or chart

ρ_c = air density at time of calibration

ρ_m = actual air density at time of measurement

Equation (4.6) shows that the density adjustment $\sqrt{\frac{\rho_c}{\rho_m}}$ is effectively applied only to the

Calibration correction and is ignored in most cases.

3.3.4. Fan Measurement Techniques. The pitot tube is an instrument to measure the velocity in high range. The precision pressure sensor has been hooked up to the tube to measure the Static, Velocity and Total Pressures. This device consists essentially of two concentric tubes. When held facing directly into an airflow, the inner tube is subjected to the total pressure of the moving airstream, p_t . The outer tube is perforated by a ring of small holes drilled at right angles to the shorter stem of the instrument and, hence, perpendicular to the direction of air movement. This tube is, therefore, not influenced by the kinetic energy of the airstream and

registers the static pressure only. A pressure gauge or manometer connected across the two tappings will indicate the difference between the total and static pressure.

The pitot tube with its lack of moving parts is inherently accurate and reliable. For accurate results its head must be aligned with the direction of airflow.

3.3.5. Multiple Measurements. Multiple measurements technique has been used by taking a series of readings by fixed-traversing method at the determined location. In traversing a circular cross section, horizontal and vertical centerlines are first laid out. Then concentric circles of equal area are constructed and the intersections of alternate ones with the centerlines are located. Velocity readings have been taken with the pitot tube placed at the intersections as shown in Figure 3.4.

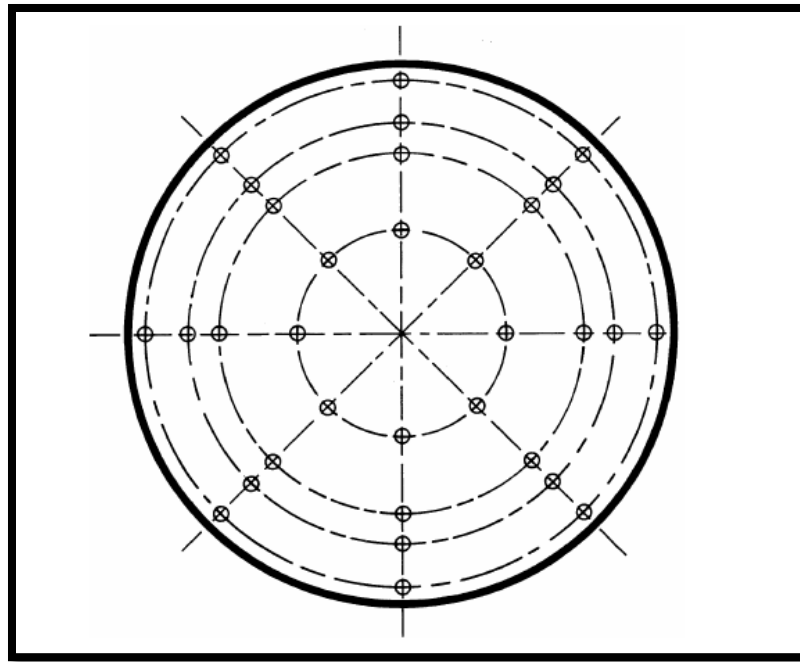

Figure 3.4. Measuring positions for circular ducts

The radii of the equal- area circles have been calculated by using the following equation:

$$r_x = r \sqrt{\frac{2x-1}{2N}} \quad (3.13)$$

The accuracy of measurement by fixed method is highly dependent on the velocity gradient and the total number of readings across the tube.

3.3.6. Entrance Length. Both laminar and turbulent flow may be either internal or external and unbounded. An internal flow is constrained by the bounding walls. Figure 3.5 shows an internal flow in a long duct. There is an entrance region where a nearly inviscid upstream flow converges and enters the tube.

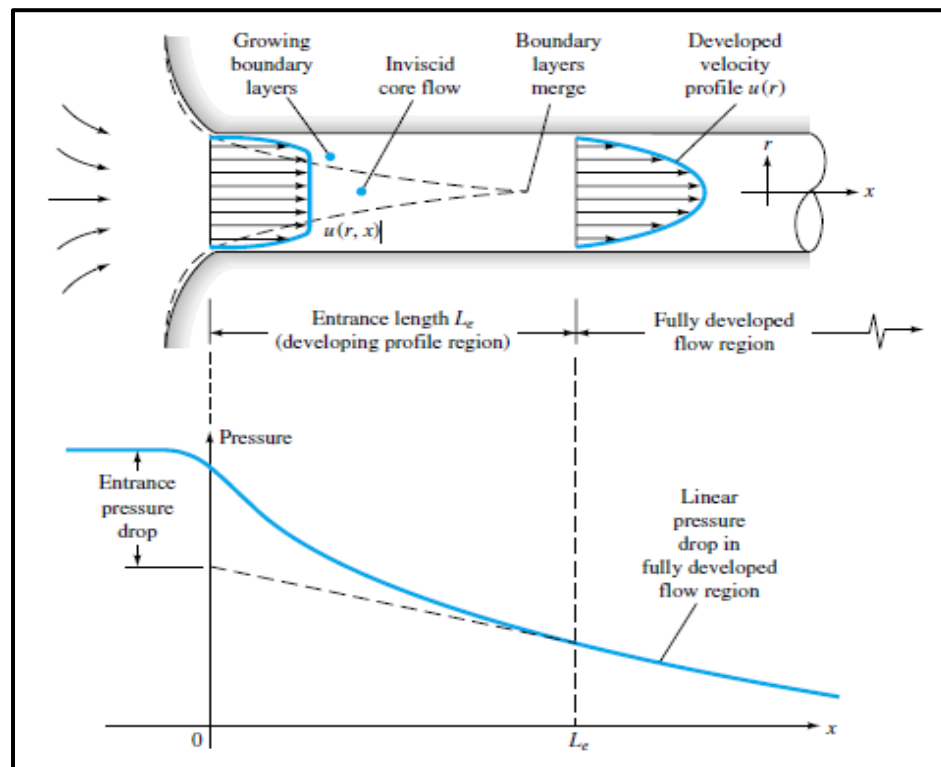

Figure 3.5. Developing velocity profile and pressure changes in duct flow entrance (White, 2007)

Viscous boundary layers grow downstream, retarding the axial flow $u(r,x)$ at the wall and thereby accelerating the center core flow to maintain incompressible continuity requirement.

$$Q = \int u \, dA = \text{const} \quad (3.14)$$

Dimensional analysis shows that the Reynolds number is the only parameter affecting entrance length. If

$$\frac{L_e}{d} = g\left(\frac{\rho V d}{\mu}\right) = g(Re_d) \quad (3.15)$$

In turbulent flow, the boundary layers grow faster and the L_e is relatively shorter. The entrance length can be calculated by using equation 3.15.

$$\frac{L_e}{d} \approx 1.6 Re_d^{\frac{1}{4}} \quad \text{for } Re_d \leq 10^7 \quad (3.16)$$

The entrance length for the ventilation duct at Missouri S&T Experimental Mine has been calculated by using the equation 3.16 as $\frac{L_e}{d} = 54.9$. Considering the actual tube has $L/d = 11.3$. Hence the entrance region takes up the fraction of $L_e/L = 4.58 = 48.5\%$ the pipe.

3.3.7. Measuring the Pressure Difference over Stoppings and Doors. The resistance of a stopping can be measured in two different ways. Two methods have been used to measure the resistance through stoppings (Oswald, 2008).

- The Single Stopping method has been described by the former United States Bureau of Mines (USBM).
- The average Stoppings value that measures the stopping resistance over a number of thee ventilation control devices.

Leakage through an individual structure can be accurately measured under a controlled environment (Vinson et al., 1977; Singh et al., 1999). One such technique was developed by the

USBM where the leakage through an individual stopping can be measured using a temporary brattice cloth with a small orifice (Vinson et al., 1977; Weiss, 1993). The brattice is installed on the low pressure side of the stopping. The air leaking through the stopping passes through the small orifice, where it is easy to measure. The pressure difference across the stopping is also measured as shown in Figures 3.6 and 3.7.

In this study, the Single Stopping method has been used. To measure the leakage through a single stopping, a temporary brattice is constructed on the low pressure side of the stopping. By leaving a small orifice in the brattice, the leakage can be measured accurately due to the consolidation of the airflow. At the time of the airflow measurement, a pressure differential across the stopping, or seal, should be measured.

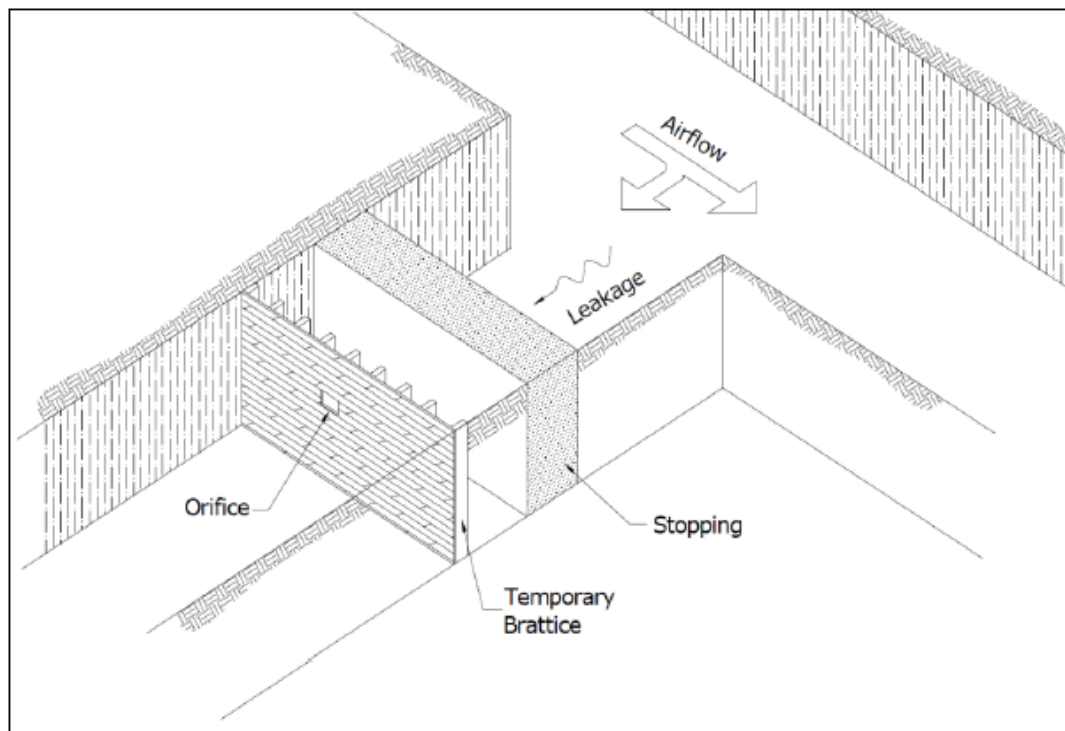

Figure 3.6. USBM method of measuring single stopping leakage and resistance (After Vinson, 1977; from Oswald, 2008)



Figure 3.7. Measuring leakage at Missouri S&T Experimental Mine stopping

4. USE OF UNDERGROUND BOOSTER FANS IN AUSTRALIA AND THE UNITED KINGDOM

4.1. INTRODUCTION

This section presents some information on design considerations pertaining to installations where booster fans are in use in non-U.S. underground coal mines and which are achieving safe and efficient atmospheric conditions. In particular, use of booster fans in Australia and the United Kingdom is examined. They are found in high and low gas conditions and on occasions where workings are located at greater than 1000m depths. Booster fan installations may be found in Mains ventilation headings where they influence flow throughout the mine, in Section headings where influence is principally on one working face or where they allow for recirculation of uncontaminated return air into the intake. Booster fans are designed with interlocking systems to control, for instance, underground fans and avoid recirculation when surface fans are unexpectedly turned off. Mine atmospheric monitoring systems are in common use. This section investigates considerations relevant to operation of booster fans safely and efficiently in underground coal mines and as a comparison with the situation in U.S. underground coal mines.

4.1.1. Australian Survey. All three of the underground coal mines in Australia that were currently using or planned to use booster fans in the near future were visited.

A summary of the mine visits and the responses to the questionnaire is given in Table 4.1.

- Mine A has installed one 600 kW centrifugal booster fan passing 170 m³/s of air at 3 kPa of total pressure to exhaust from two working districts. The fan is installed in a 150 mm thick concrete wall and equipped with environmental and fan monitors. A booster fan approach to maintaining required airflow underground was selected as installation of a shaft was not possible in an environmentally sensitive area. It is planned to operate the fan for about 5 to 6 years by which time installation of a shaft for ventilation requirements will be possible and receive environmental approval.

- Mine B operates four booster fans, each fan with a capacity of 150 m³/s of air at 3 kPa of total pressure. The fans are equipped with surface-controlled environmental and fan monitors. Rigorous risk analyses were reviewed at the chief inspectorate level prior to the installation as they were the first booster fan investments in Australia in many years. A booster fan approach to maintaining required airflow underground was selected as shaft installation was not possible in an environmentally sensitive area. In addition booster fans have proved to be the most economic solution to maintaining ventilation in a mine which has been working for a long period and with extended workings over a large area. The fans are considered to be an integral part of the ventilation system and a long term investment. It was stated that “the mine would not be operating today without the fans”.
- Mine C operated two 400 kW centrifugal booster fans over a recent six-year period without any major problems. Booster fan investment occurred as it was deemed to be the most economic approach to maintaining required airflow underground. Recently, the mine ventilation system went through a major upgrade that included the sinking of a new shaft and the installation of larger capacity fans. The fans have been decommissioned.

Table 4.1. Summary of Australian underground coal mine survey

Scope of Survey	Mine A	Mine B	Mine C
Section A – General Information			
1. Mining method	Longwall (LW)	Longwall	Longwall
2. Production, million tpy	2 million	3.5 million	3.2 million
3. Sections: LW or Dev	1 LW + 2 Dev supersections	1 LW + 2 Dev	1 LW + 2 Dev
4. Max overburden	500 m	550 m	320 m
5. Max distance from surface to workings	9 km	10 km	9.2 km
6. No. of employees	350	350	400

Table 4.1. Summary of Australian underground coal mine survey (cont.)

7. Equipment: E = electrical; D = diesel	1 E + 3D	1 E + 3D	1 E + 3D
8. Mains. Configuration: I = intake; R = return	2 I + 2 R + belt	3 I + 2 R + belt	3 I + 2 R + belt
9. Main contaminants	Diesel, methane	CO, CH ₄ , diesel	CO, CH ₄ , diesel, heat, sponcom
10. Ventilation system	Exhaust	Exhaust	Exhaust
11. Face ventilation	Auxiliary fans	Auxiliary fans	Auxiliary fans
12. Coal transportation	Conveyor	Conveyor	Conveyor
Section B – Ventilation System			
1. No. of main fans, type, diameter Motor size Quantity, m ³ /s Pressure, kPa	2 centrifugal, 1.8 m 2 x 1.8 MW/ea 250 7.0	2 centrifugal, 2.5 m 2 x 750 kW/ea 175 3.3	2 centrifugal, 2.3 m 2 x 770 kW/ea 320 2.3
2. Atmospheric monitoring system (AMS)	Yes + fan monitoring	Yes + fan monitoring	Yes + fan monitoring
3. Factors monitored	CO, CH ₄ , CO ₂ , P, Temp, Vibration, tube bundle	CO, CH ₄ , CO ₂ , P, Temp, Vibration, tube bundle	CO, CH ₄ , CO ₂ , P, Temp, Vibration, tube bundle
4. Belt air used for ventilation	Yes	Yes	Yes
Section C – Utilization of Booster Fans			
1. No. of booster fans, type	1 centrifugal	4 centrifugal	2 centrifugal
2. Fan duty: quantity, m ³ /s Pressure, kPa	170 3.0	150 3.0	150 – 160 2.0
3. Impeller diameter, m	N/A	3 m	N/A
4. AMS for booster fan monitoring: factors	Q, P, Vibration B temp., CO	P, CH ₄ B temp., CO	Q, P, Vibration, CH ₄ B temp., CO
5. Location & reasons for site selection	Return, avoidance of travel route, min recirc.	Return, avoidance of travel route, min recirc.	Return, avoidance of travel route, min recirc.
6. Other reasons for site selection	Distance from surface High resistance return Leakage control	Distance from surface High resistance return Leakage control	Distance from surface, minimize recirculation Sponcom potential
Design Evaluation	Risk assessment & Experts review	Risk assessment & Experts' review	Risk assessment & Experts' review

Table 4.1. Summary of Australian underground coal mine survey (cont.)

Electrical Interlocking	Main & booster fans Interlocked	Main & booster fans Interlocked	Main & booster fans Interlocked
Life of Fan Installation	4- 5 yrs	10 yrs plus	Removed after 6 yrs.
Section D – Questions for Coal Mines			
1. Questions to mine related to Inspectorate regarding booster fans : a) If permitted, would you use again? b) Was getting permission unduly onerous?	Yes Yes	Yes Yes	Yes & No Not trivial
2. Which factor contributed most to your desire to use a booster fan?	Distance from surface High resistance circuit	N/A N/A	Buying time; Essential before surface fan system was upgraded
3. Advantages of using booster fans	Increased flow in high Resistance circuits	Mine could not operate without them	Increased flow in high Resistance circuits; Minimizes leakage
4. Disadvantages of using a booster fans	Risk of uncontrolled recirculation & fire	Risk of uncontrolled Recirculation. Required 35 kPa press rated doors	High risk and needs good management

4.1.2. United Kingdom Survey. Three of the five significant underground coal mines in Britain using booster fans were visited. There is a long history of booster fan use and some examples of current practice observed in Britain can be briefly summarized as follows:

- Booster fan installations are accepted as a safe and effective means of ventilating sections. In all of the mines visited, booster fans were viewed as the only option for providing adequate ventilation underground.

- Both axial and centrifugal fans are in use with installations in concrete bulkheads. Axial fans are installed in clusters with up to four two-stage fans per site. Heavy duty airlock doors are in use. A double inlet centrifugal fan is in use in one mine.
- Booster fan sites are equipped with monitors at each fan. Fan parameters included differential pressure, motor and bearing temperatures and air velocity. Environmental parameters included methane, carbon monoxide and smoke.
- Booster fans are more likely to be located in the returns and in series with the main fans. The motors and electrical components are also located in the returns and are enclosed in flame proof housings. There is no electrical interlocking between the main fans and the booster fans at any of the mines visited.
- Recirculation and series ventilation are not strictly prohibited, and series ventilation is used under extreme circumstances. It was made clear that on average mines were recirculating about 10 % of air.
- The UK inspectorate has a comprehensive system for approving booster fan installations.
- The use of booster fans in an average well-engineered coal mine can only be justified where there is a quantified need for booster fan to ventilate part of a mine.

A summary of the mine visits and questionnaire responses is given in Table 4.2.

Table 4.2 Summary for United Kingdom underground coal mine survey

Scope of Survey	Mine A	Mine B	Mine C
Section A – General Information			
1. Mining method	Longwall	Longwall	Longwall
2. Production rate, million tpy	2.5	3.0	2.3
3. Active: LW or Dev	1LW + 1Dev + Sa	1 LW + 4 Dev	1 LW + 4 Dev

Table 4.2 Summary for United Kingdom underground coal mine survey (cont.)

4. Max overburden, m	850	1,000	800
5. Max distance from surface to working, km	7.5	8	9
6. No. of employees	700	500	650
7. Equipment: E = electrical; D = diesel; B= battery	Both B and D units	2 E	B
8. Mains Configuration: I = intake; R = return	1 I + 1 R; no bleeders	1 I + 1 R + 2 Gateroads; no bleeders	1 I + 1 R + 2 Gateroads; no bleeders
9. Main contaminants	Dust	Dust, CH ₄ , Heat	Dust, CH ₄ , heat
10. Vent system	Exhaust	Exhaust	Blowing
11. Face ventilation	Antitropal vent in LW panel	Auxiliary fans	Auxiliary fans
12. Coal transportation	Conveyor	Conveyor	Conveyor and shaft skips
13. Additional information	Auxiliary ventilation flow rate 6.5 m ³ /s	Booster fan located 4km from main shaft	Methane drainage at face, above and below the seam
Section B – Ventilation System			
1. No of main fans, type, dia Motor size Quantity, m ³ /s Pressure, kPa	2 centrifugal, 757 kW/ea 169 2.8	2 centrifugal, 5.3 m 2300 kW/ea 280 5.5	2 centrifugal, 4.14 m 2 x 770 kW/ea 290 2.5
2. Atmospheric monitoring system (AMS)	Yes	Yes	Yes + fan monitoring
3. Factors monitored	CO, CH ₄ , CO ₂ , fan P&factors, tube bundle	CO, CH ₄ , CO ₂ , fan P&factors, tube bundle	CO, CH ₄ , CO ₂ , fan P&factors tube bundle
4. AMS used for fan monitoring	Yes	Yes	Yes
5. Belt air used for ventilation	No	Yes	Yes (return)
Section C – Utilization of Booster Fans			
1. No. of booster fans, type	Four 2 x 2, centrifugal	1, centrifugal	1centrifugal, two cluster sets of 4 Axial fans
2. Fan duty: q, m ³ /s Pressure, kPa	120 3.5	138 7.4	Cent 68; Axial 67 Cent 7.0, Axial 2.5

Table 4.2 Summary for United Kingdom underground coal mine survey (cont.)

3. Impeller diameter, m	2.0	2.05	Axial: 4 x 2 x 1.22 ; 4 x 2 x 1.22 Centrifugal: 1 x 1.6
4. AMS for booster fan monitoring: factors	Q, P, Vibration B temp., CO, CH ₄ , Alert	P, Vibration, CH ₄ B temp, Alert, CO	P, Vibration, CH ₄ , B temp, CO, Alert, Water curtain
5. Additional information	Fans are installed in stone above coal seam to prevent sponcom.		Imbalance with fan position and flow turbulence
6. Location & reasons for site selection	Min leakage, avoidance of travel route, min recirculation.	Return, avoidance of travel route, min recirc, min leakage.	Return, avoidance of travel route, min recirc, min leakage, reverse pressure outby
7. Other reasons for site selection	High resistance return Leakage control Distance from surface More cost effective Control sponcom	Sponcom potential, high resistance return, leakage control, distance from surface, cost effective	Sponcom potential, leakage control, distance from surface, high resistance airways, minimize recirculation
Design Evaluation	Reviewed by experts	Reviewed by experts	Reviewed by experts
Electrical Interlocking	Main & booster fans Interlocked	Main & booster fans Interlocked	
Life of Fan	unknown	3 yrs	20 yrs.
Section D – Questions for Coal Mines			
1. Inspectorate Questions on booster fans: a) If permitted, would you use booster again? b) Was getting permission unduly onerous?	Yes No	Yes No	Yes No
2. Which factor contributed most to your desire to use a booster fan?	Control Sponcom Benefits outweighs the negative issues	Sponcom, high resistance airways, leakage control, distance from surface, cost effective	Cost effective, high resistance airways, leakage control, distance from surface, sponcom

Table 4.2 Summary for United Kingdom underground coal mine survey (cont.)

3. Advantages of using booster fans	The mine utilizes two main fans at about 2.8 kPa static pressure and 2-two stage booster fans at 3.5 kPa of pressure difference across the bulkhead. If no booster fans were used, the main fan pressure could be in the order of 13 kPa.	Reduce overall power cost, reduce air pressure differentials, reduce leakage, increase flow rate in high resistance airways, decrease main fan pressure requirement	Increase flow rate
4. Disadvantages of using a booster fans	Increased number of airlock doors needed.	Installing AMS, increase complexity of the ventilation system, increase noise and dust, limited ability to access fan in case of fire, risk of recirculation	Increase noise and dust, Increased complexity of vent system, airlock transport routes

5. UNDERGROUND COAL MINE VENTILATION NETWORK BEHAVIOUR AND OPTIMIZATION WITH BOOSTER FANS

5.1. INTRODUCTION

A study has been undertaken to examine utilization of a booster fan in an underground coal mine in the Eastern United States. Hypothetical simulations of situations in which greater levels of seam methane are encountered and alternatives to maintain safe ventilation have been undertaken. Options examined looking at cases where more ventilation is made available underground from alternatives of the driving of more intake or return shafts, the use of various surface main fan combinations and the use of various booster fan combinations.

5.2. MINE GENERAL INFORMATION

This underground coal mine uses the room and pillar method. The coal seam is horizontal with thickness of 1.8 m. Development mains are driven with eleven entries (four intakes, four returns and three neutral airways). Sub-mains are driven with two intakes, two returns and three neutral airways.

Currently the mine has five active working faces ventilated by a 670 kW axial fan using a pull exhausting system. The mine currently exhausts 230 m³/s of air at static pressure of 1.95 kPa. The input power of 460 kW is required. A pressure and air quantity survey has been conducted to construct the base ventilation model. This has been expanded to a five-year production plan using the current mine schedule approach as seen in Figure 5.1 and Figure 5.2.

Various measurements have been taken undertaken underground. It was determined that the Ventsim program was the best internationally available software for undertaking this form of study. Ventsim Visual is a recent upgraded version of Ventsim Classic software and is capable of simulating airflow, contaminants and financial considerations modeling. Ventsim Visual allows

VnetPC mine models to be translated into Ventsim simulation files for various engineering analyses.



Figure 5.1. Ventsim visual, schematic view of expanded model

The study began with importing a DXF file to Ventsim Visual from the current workings expanded to the mine's five-year plan (which had been prepared by the University of Utah's booster fan research team). The mine is an extensive room and pillar mine with five working faces. Unit #1 and #3 dump return air to Main West Return, Unit #2 and #4 dump air to Main East Return. Unit #5 dumps air to Main North Return. Main East Return and Main West Return then dump air to Main North Return which goes to the exhaust upcasting shaft (Figure 5.2).

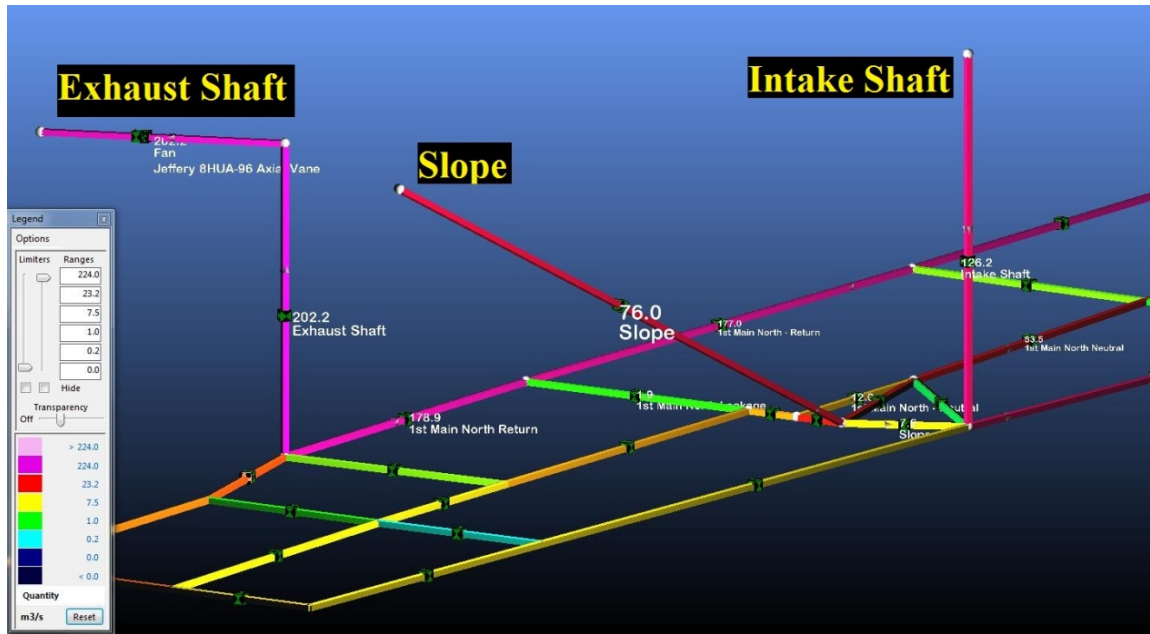

Figure 5.2. View of ventilation infrastructure

The original five-year plan and seven different alternative hypothetical scenarios have been simulated to determine the optimal option which offers the lowest total cost (capital cost plus operating cost) as well as provides required airflows at working faces. In this hypothetical exercise higher coal seam methane contents ($1\text{m}^3 \text{CH}_4/\text{t}$ and $2\text{m}^3 \text{CH}_4/\text{t}$) are presumed to be being encountered in mining coal seams in five years.

Options examined look at cases where more ventilation is made available underground from alternatives of the

- The driving of more intake or return shafts,
- The use of various surface main fan combinations and
- The use of various booster fan combinations.

5.3. ASSUMPTIONS AND VENTILATION MODEL PREPARATION

The total mine resistance substantially increases as an underground coal mine gets deeper and workings more extensive. The demand for fresh air at working faces forces engineers to redesign or upgrade the existing ventilation system (Wempen, Calizaya and Peterson, 2011). Several scenarios for improving a ventilation situation such as altering the main surface fans, adding intake shafts or exhaust shafts or installing booster fans to the system have been examined.

Booster fans are technically main fans which are installed underground to maintain the required airflow by overcoming the mine resistance. Booster fans can reduce the pressure required from the main fan and decrease the system leakage and the total required air power (Martikainen and Taylor, 2010). The objective of this study is to find the optimum method for ventilating an underground U.S. coal mine. The optimal ventilation design is to determine the best combination of fans and regulators that will fulfill the airflow requirements in the mine and minimize the present value of the total cost. Both booster fans and regulators are used to control air distribution throughout the mine network. Regulators destroy energy (initially put into the mine ventilation system by fans) while booster fans add energy to the system; from an energy balance point of view airflow control through use of booster fans will be more efficient than use of regulators.

This study presents five different scenarios simulating the ventilation network of an underground coal mine in the U.S. The study started by expanding the model from the current workings to the mine's five-year production plan. The airflow simulation has been conducted as well as contaminant simulation. In addition, the cost study has been done to determine the uneconomic and impractical scenarios especially regarding power consumption. Scenarios 4 and 6 can meet the required face airflows. However scenario 6, with the use of two booster fans, is recommended as being the best alternative in the five-year plan after taking into account the total cost and the expected life of the new infrastructure

Methane dilution calculations have been undertaken. These are based on a minimum of $15\text{m}^3/\text{s}$ of fresh air being required at each of the working faces.

The Safe Scenario: A liberation rate of $2.0\text{ m}^3\text{ CH}_4/\text{t}$ from broken coal with mining rate of 345t/hr ($265\text{m}^3\text{ coal/hr}$) at density 1.3 t/m^3 has been used. An airflow rate of greater than $15\text{m}^3/\text{s}$ across a working face is deemed to be required to give CH_4 concentrations of less than 1.0% in face air. The steady state contaminant simulation has been performed based on the requirement of an allowable concentration of methane at each individual working face. The spread of methane concentrations in downstream airways is identified.

The Very Safe Scenario: A liberation rate of $1.0\text{m}^3\text{ CH}_4/\text{t}$ from broken coal with mining rate of 345t/hr ($265\text{m}^3\text{ coal/hr}$) at density 1.3t/m^3 has been maintained. The airflow rate of greater than $15\text{m}^3/\text{s}$ is deemed to be required to give CH_4 concentrations of less than 0.5% in face air. The simulation has been performed by adding 0.5% methane to each individual faces and tracking the spread of the contaminant. The results show the concentrations of the methane in the network which emphasizes that the predicted concentration in all network airways is lower than 0.5%.

5.3.1. Airflow and Contaminant Simulations. Methane dilution calculations have been undertaken. These are based on a minimum of $15\text{m}^3/\text{s}$ of fresh air being required at each of the working faces.

The Safe Scenario: A liberation rate of $2.0\text{ m}^3\text{ CH}_4/\text{t}$ from broken coal with mining rate of 345t/hr ($265\text{m}^3\text{ coal/hr}$) at density 1.3 t/m^3 has been used. An airflow rate of greater than $15\text{m}^3/\text{s}$ across a working face is deemed to be required to give CH_4 concentrations of less than 1.0% in face air. The steady state contaminant simulation has been performed based on the requirement of an allowable concentration of methane at each individual working face. The spread of methane concentrations in downstream airways is identified.

The Very Safe Scenario: A liberation rate of $1.0\text{m}^3\text{ CH}_4/\text{t}$ from broken coal with mining rate of 345t/hr ($265\text{m}^3\text{ coal/hr}$) at density 1.3t/m^3 has been maintained. The airflow rate of greater

than $15\text{m}^3/\text{s}$ is deemed to be required to give CH_4 concentrations of less than 0.5% in face air. The simulation has been performed by adding 0.5% methane to each individual faces and tracking the spread of the contaminant. The results show the concentrations of the methane in the network which emphasizes that the predicted concentration in all network airways is lower than 0.5%.

The seven scenarios show that following the addition of either 1% or 0.5% methane to each working face, the average of methane across all five faces and consequently throughout the mine network is respectively less than these figures. This is because the simulation optimizes for one critical face minimum quantity and consequently other faces receive more than the minimum air, a situation that is rarely a problem.

The CH_4 concentration has been diluted through leakage as air is lost through stopping leakages. The study aims to undertake a technical and cost comparison of ventilation of a typical (although artificial) model of a modern Room and Pillar mine layout.

5.3.2. Cost Study Analysis. Financial simulation modeling has estimated optimum ventilation infrastructure size by considering mining costs as well as the life of mine ventilation operating costs. These simulations can, for instance, help to optimize airway sizes and save substantial money over the life of a mine. This approach optimizes the size of the development airways to maximize cost savings in ventilation while minimizing mining costs. Increasing airway size is the easiest way to reduce frictional pressure losses and decrease ventilation costs in a mine. However it causes additional mining capital costs and this is further exacerbated by “time value of money” considerations. Operating costs include electricity, maintenance and installation charges over five years discounted at 10% to the Present Value. Another factor to consider is the length of the time that the airway is required to carry air.

5.3.3. Cost Study. To determine the economic viability of a proposed mine, estimated costs and anticipated values have been compared. Costs are categorized as either capital or operating. Operating costs are those that can be directly expensed against revenues as they

accrue and include funds that an organization spends operating the equipment and paying wages and salaries. Capital costs are those that cannot be fully expensed in the year incurred and include items such as infrastructure, excavating cost, working capital and purchasing equipment (SME handbook, 2011).

5.3.4. Capital Cost of Fans. The capital cost for one underground booster fan that meets the requirements has been assumed to be \$105,000 (including motor and fan accessories). Scenario 6 needs two of these fans, and with installation costs, a total of \$310,000 is required. The installation fee has been assumed to be 50 percent of total material fee (Mine and Mill equipment 2010).

5.3.5. Capital Cost of Shaft. The cost of shaft sinking depends on the method adopted, cross sectional area of the shaft and the support lining method. It has been assumed in this exercise that the shaft is excavated by raise boring. This cost includes a fixed cost for mobilizing the raise boring equipment (SME Handbook, 2011). In this research the sinking costs of a circular concreted shaft with diameter of 2.2m, 2.8m and 4.2 have been assumed to be \$9,760/m, 10,500/m and \$14,500/m, respectively (Mining Cost Service, 2009).

5.4. SIMULATION ALTERNATIVES

Several scenarios have been conducted to determine the optimal one.

5.4.1. Scenario 1. The simulation has been conducted based on the expanded model and current ventilation infrastructure for the next five years. Typical resistance values for the mine were used in the projected model.

It was determined that unit #1 and #3 are the farthest sections and due to the distance and airways resistance, the available airflow at working faces is less than the minimum required. Unit #4 also does not have the minimum required airflow. Quantity across the #2 and #5 faces is marginal at best. According to the results, the current surface fan infrastructure is not capable of ventilating the mine and meeting methane requirements.

Table 5.1 shows the simulation results. Scenarios #2 to #7 are based on ventilation changes from this expanded five-year plan model.

Table 5.1. Scenario 1 predicted airflows on working faces

Locations	Predicted Values
Exhaust Shaft	205.4 m ³ /s
Intake Shaft	121.4 m ³ /s
Slope	74.3 m ³ /s
Unit#1	8.9 m ³ /s
Unit#2	13.4 m ³ /s
Unit#3	7.9 m ³ /s
Unit#4	6.2 m ³ /s
Unit#5	13.2 m ³ /s
Input Power	792 kW
Annual Operating Cost	\$693,270

The input power (fan air power) has been calculated on Fan Total Pressure and represents the power the fan motor is applying to the fan blades to generate the pressure and flow through the fan. The annual operating cost is derived from the power cost set in the Setting Menus for a fan operating at this duty point continuously for a full year (Ventsim Visual, 2012).

5.4.2. Scenario 2.

This scenario has an intake shaft added in 1st Main East. The simulation adjusts the flow through the airway based on the resistance of each airway size. The required shaft diameter can be determined from the mining costs and the required airflow. A schematic view of the shaft and the simulation results is in Table 5.2.

The main fan operates at static pressure of 0.22 kPa and exhausts 206.1 m³/s of air. Under this simulation the full quantity of air is unaltered and the minimum air requirement in the eastern part of the mine (Units 2 and 4) has been met. However, not enough air reaches to the other three faces.

Financial simulation estimates optimum ventilation infrastructure size by considering mining costs as well as life of mine ventilation operating costs. This simulation can help optimize airway sizes and save money over the life of a mine.

The study has optimized the size of the shaft development airways, to maximize cost savings in ventilation, while minimizing mining costs. Increasing airway size is the easiest way to reduce frictional pressure losses and decrease ventilation costs in a mine.

Table 5.2. Scenario 2 predicted airflows on working faces

Locations	Predicted Values
Exhaust Shaft	206.1 m ³ /s
Intake Shaft	73 m ³ /s
Slope	38.1 m ³ /s
Intake Shaft #2	95 m ³ /s
Unit#1	6.7 m ³ /s
Unit#2	15.8 m ³ /s
Unit#3	6.3 m ³ /s
Unit#4	15.0 m ³ /s
Unit#5	14.4 m ³ /s
Input Power	813.4 kW
Annual Operating Cost	\$712,511
Capital Cost	\$1,464,000

The study has optimized the size of the shaft development airways, to maximize cost savings in ventilation, while minimizing mining costs. Increasing airway size is the easiest way to reduce frictional pressure losses and decrease ventilation. However it creates additional cost and this is further exacerbated by the “time value of money” which dictates that a dollar saved in mining costs now is worth more than a dollar saved in ventilation costs in the future. It was found that the optimum diameter of intake shaft is 2.8 m. Figure 5.3 shows the schematic view of the added intake shaft to the ventilation system.

Another factor to consider is how long the airway is required to carry air, which affects how much ventilation cost can be saved in the future. Ventsim Visual financial simulator takes this into account and simulates up to 10 different airway sizes. The simulator reports the effect on mining cost and ventilation costs as the Net Present Value (NPV) cost adjusted overall cost.

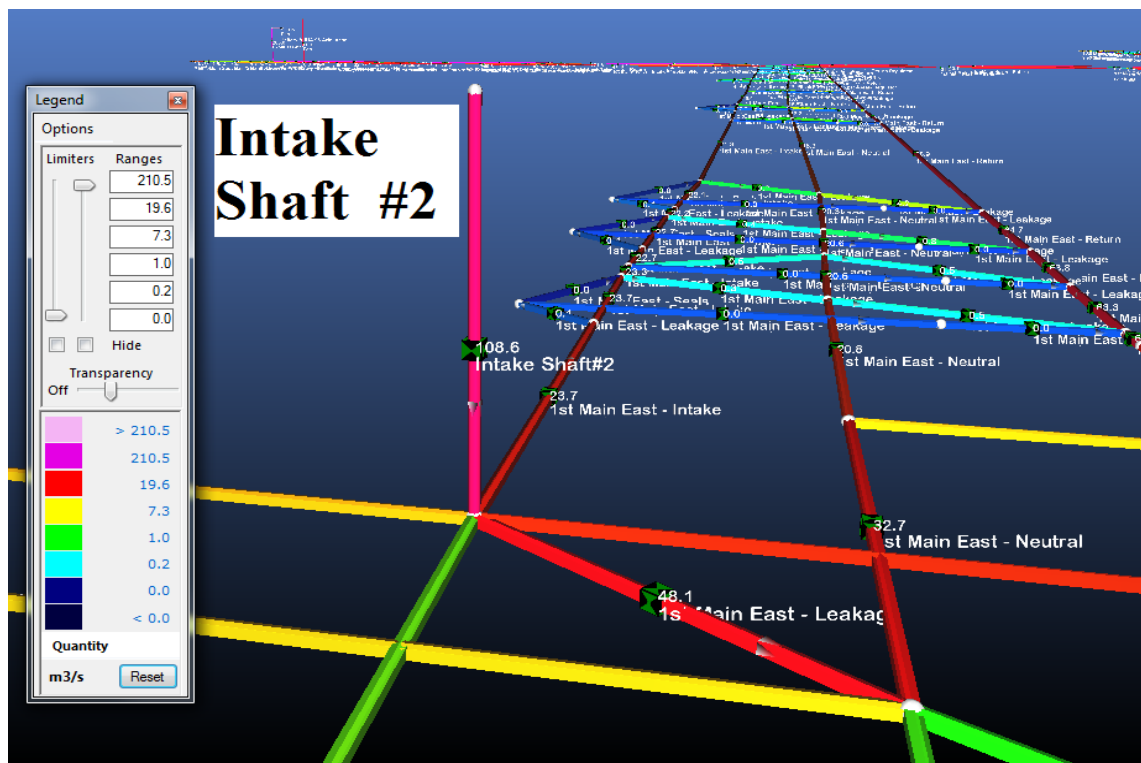

Figure 5.3. Ventsim Visual schematic view of intake shaft #2

5.4.3. Scenario 3. Two intake shafts were added to the model in order to supply the required air at faces. Intake shaft #1 has been added to 1st Main East and Intake shaft #2 is added to 2nd Main West.

The total exhausted air quantity has not been increased. An optimized diameter of 2.4m has been selected based on the lowest excavation cost. Table 5.3 shows the predicted results.

This scenario almost meets the minimum requirements for all units; however, the air quantity at unit #3 which is the farthest face from both faces has not been reached. Moreover, the shaft excavation operation is a time and cost consuming exercise which causes this scenario to have a high capital cost.

The advantage of sinking two small diameter intake shafts is that the fresh air will travel shorter distance compared to the air provided from main intake shaft and the slope.

Table 5.3. Scenario 3 predicted airflows on working faces

Locations	Predicted Values
Exhaust Shaft	202.2 m ³ /s
Intake Shaft	43.2 m ³ /s
Slope	24.6 m ³ /s
Intake Shaft #2	74.5 m ³ /s
Intake Shaft #3	59.9 m ³ /s
Unit#1	15.1 m ³ /s
Unit#2	15.2 m ³ /s
Unit#3	12.4 m ³ /s
Unit#4	15.3 m ³ /s
Unit#5	15.4 m ³ /s
Input Power	811 kW
Annual Operating Cost	710,407 \$
Capital Cost	3,150,000 \$

5.4.4. Scenario 4. Exhaust Shaft #2 has been added to the base case in 1st Main East Return. A fan similar to the main fan is added to the network and the optimal diameter of 4.2m is selected. Table 5.4 shows the results for this scenario.

Ventsim simulator also designs optimum ventilation infrastructure size by considering mining costs as well as life of mine ventilation operating costs. This function can help optimize airway sizes and save substantial money over the life of a mine.

Table 5.4. Scenario 4 predicted airflows on working faces

Locations	Predicted Values
Exhaust Shaft	165.4 m ³ /s
Intake Shaft	260.1 m ³ /s
Slope	96.5 m ³ /s
Exhaust Shaft #2	200.2 m ³ /s
Unit#1	17.4 m ³ /s
Unit#2	18.3 m ³ /s
Unit#3	15.2 m ³ /s
Unit#4	16.0 m ³ /s
Unit#5	17.4 m ³ /s
Input Power	1624.3 kW
Annual Operating Cost	1,420,279 \$
Capital Cost	2,665,000 \$

The simulation results in Table 5.4 show that this alternative fulfills the air requirements at working faces. However the operating cost is increased dramatically. The capital cost is also

increased since sinking a permanent ventilation shaft and purchase and installation of a second surface fan is an expensive process.

5.4.5. Scenario 5. A second surface exhaust fan #2 (similar to a Jeffery 8HUA-96 Axial Vane) has been added in parallel (Figure 5.4) to the original Main fan. The air simulation was successful but with warning that “the lack of airflow rate causes the fans to be stalled”. One of the fans is exhausting $123.1 \text{ m}^3/\text{s}$ at static pressure of 0.33 kPa and the second is exhausting $129.9 \text{ m}^3/\text{s}$ at the same static pressure.

The operating points drops off the curve (Figure 5.5). The network efficiency is estimated at 57.4% . This scenario does not meet the requirements at any of the working faces. Table 5.5 shows the predicted simulation results.



Figure 5.4. Ventsim Visual schematic view of exhaust shaft #2

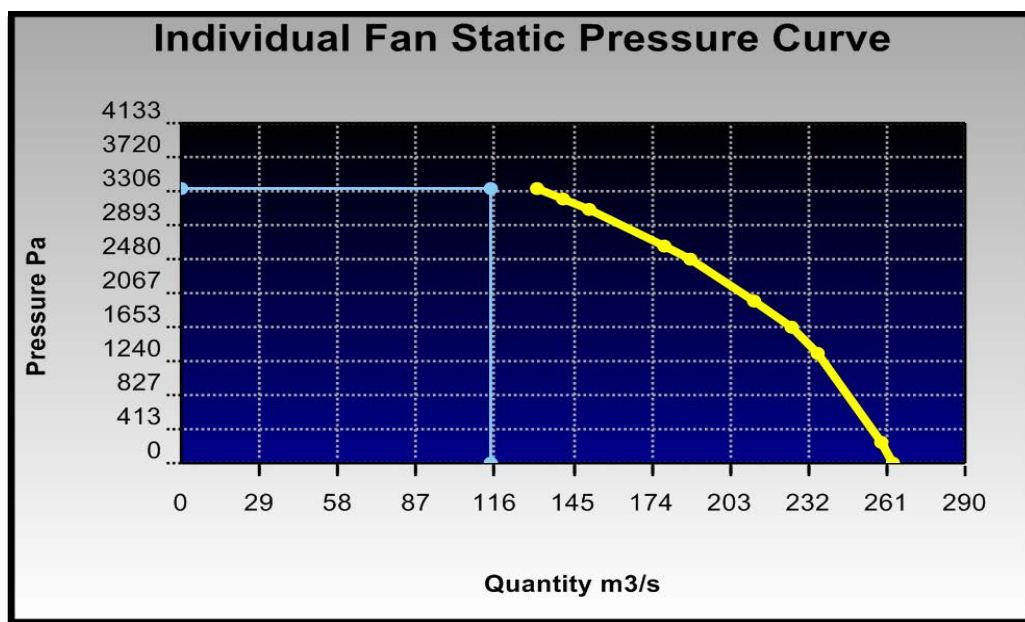

Figure 5.5. Stalled fans characteristics curve and operating point

Table 5.5. Scenario 5 predicted airflows on working faces

Locations	Predicted Values
Exhaust Shaft	253 m ³ /s
Intake Shaft	162 m ³ /s
Slope	91 m ³ /s
Exhaust Fan #1	123.1 m ³ /s
Exhaust Fan #2	129.9 m ³ /s
Unit#1	9.2 m ³ /s
Unit#2	10.5 m ³ /s
Unit#3	9.4 m ³ /s
Unit#4	4.4 m ³ /s
Unit#5	13.1 m ³ /s
Input Power	1402.4 kW
Annual Operating Cost	\$1,228,476
Capital Cost	\$490,000

Although in this scenario two surface fans are working in parallel the total amount of exhausted air is not significantly changed. Based on the fan laws, total air quantity should increase. The reason for this could be the high resistance due to the distance to the workings and also limited diameter of the exhaust shaft. In this scenario the capital cost consists of the cost of purchasing the second surface fan and mechanical and civil works needed to add the fan.

5.4.6. Scenario 6. Since the current surface main fan by itself is physically incapable of meeting the airflow requirements, two booster fans have been added to the network to add in series air pressure to overcome resistance.

Booster fans could be installed in the main airways or in a split of the main airways. Booster fan #1 has been added to the 1st Main East Return and Booster fan #2 has been added to 2nd Main West Return. Figures 5.6 and 5.7 show the fan characteristics curves. Figure 5.8 shows the locations of the booster fans in the network. This scenario meets the required airflow at working faces with relatively low additional capital cost. Table 5.6 shows the simulation results.

Booster fan installation may require the development of a bypass drift, widening of an existing drift, installation of airlock doors, and miscellaneous civil constructions. Testing involves checking the fan for stability, and running it initially at no load with the airlock doors open and then at full load with the doors closed (Calizaya, Stephens and Gillies, 2010).

Inappropriate booster fan selection or installation introduces potential hazards including an increased likelihood of mine fires or recirculation of contaminants. Addition of bulkheads and changing regulators downstream of the booster fans may be required to adjust the resistances of branches to control air distribution. Most changes need to be done in 2nd Main west, 1st Main East and the intersection of Main North Vs 2nd Main.

In this scenario, the capital cost is the cost of purchasing and installing two booster fans in determined sections. The capital cost of \$105,000 for each fan has been assumed. This cost includes the cost of motor and other fan accessories. The installation cost has been assumed to be 50% of the fan cost.

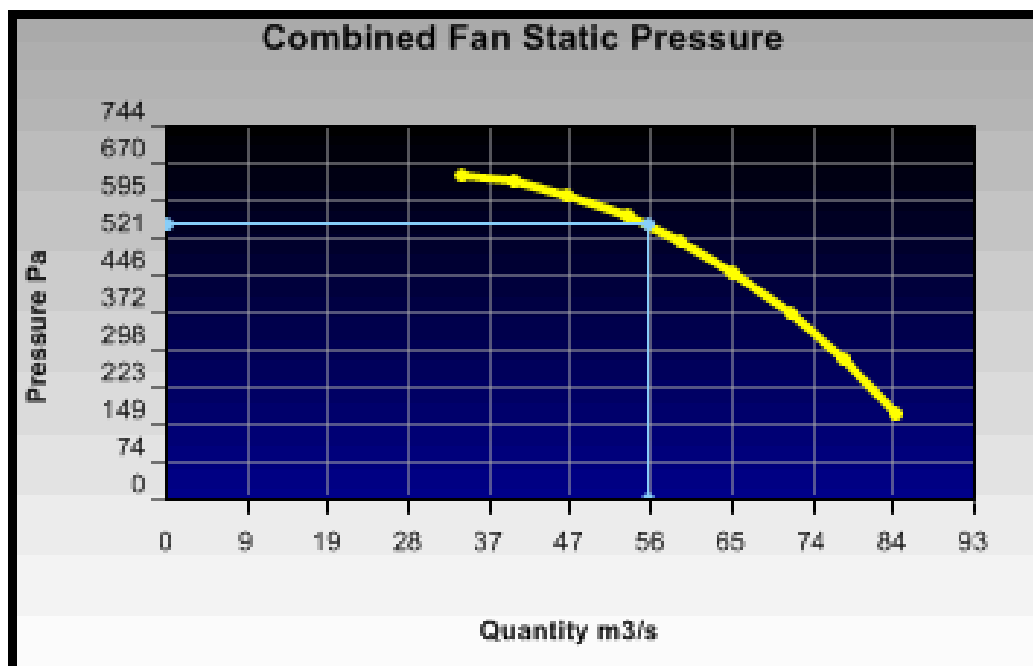

Figure 5.6. Booster fan #2 characteristics curve, 1st main east

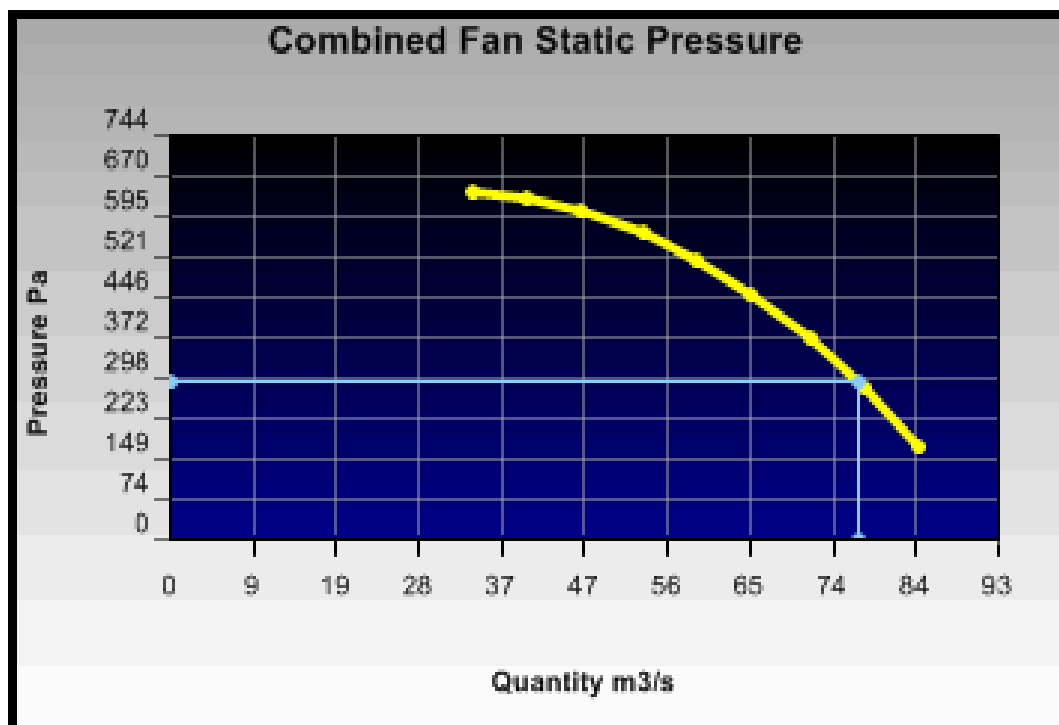

Figure 5.7. Booster fan #1 characteristics curve, 2nd main west

Table 5.6. Scenario 6 predicted airflows on working faces

Locations	Predicted Values
Exhaust Shaft	204.4 m ³ /s
Intake Shaft	148.6 m ³ /s
Slope	55.8 m ³ /s
Booster fan #1	77.1 m ³ /s
Booster fan #2	55.3 m ³ /s
Unit#1	17.2 m ³ /s
Unit#2	15.0 m ³ /s
Unit#3	15.3 m ³ /s
Unit#4	15.0 m ³ /s
Unit#5	15.0 m ³ /s
Input Power	915.7 kW
Annual Operating Cost	\$802,120
Capital Cost	\$310,000

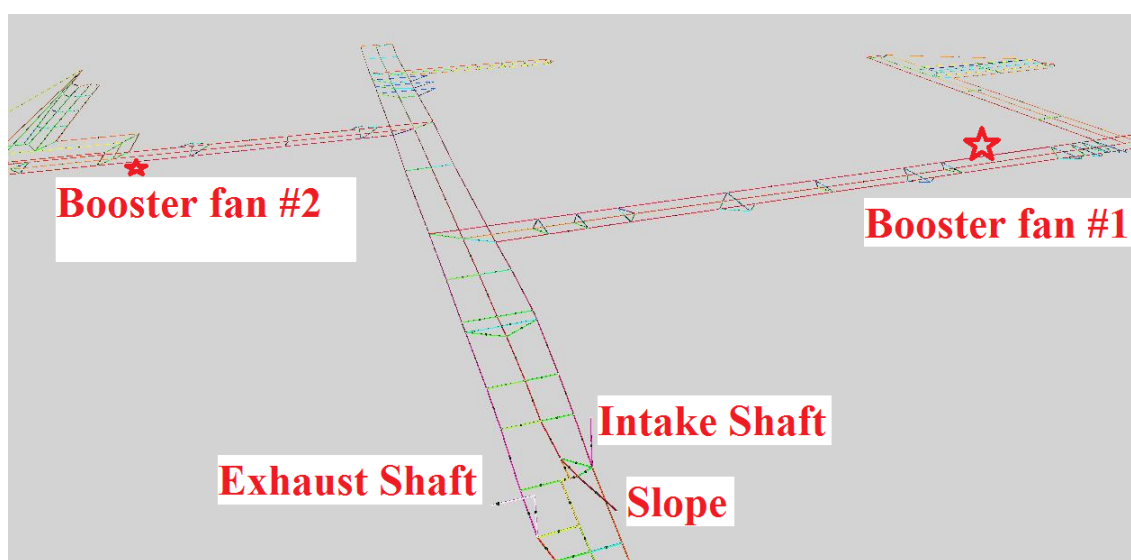

Figure 5.8. Booster fan locations

5.4.7. Scenario 7. One booster fan added to Main North Return to increase air pressure and reduced overall power costs. Although the capital cost is lower than some other scenarios, the booster fan could not meet the required airflow at the working faces. The booster fan exhausts $177\text{m}^3/\text{s}$ at static pressure of 0.61 kPa with efficiency of 68%. Table 5.7 shows predicted values for this scenario.

The air quantities at working faces do not meet the minimum requirement. The amount of air has been adjusted by adding the regulators to the network. However the average amount of fresh air at working faces is $11.5\text{ m}^3/\text{s}$. The capital cost in this scenario is the cost of purchasing one booster fan with all accessories of \$340,000 plus installation fee \$150,000.

Table 5.7. Scenario 7 predicted airflows on working faces

Locations	Predicted Values
Exhaust Shaft	$208.2\text{ m}^3/\text{s}$
Intake Shaft	$130.6\text{ m}^3/\text{s}$
Slope	$77.6\text{ m}^3/\text{s}$
Booster fan	$177\text{ m}^3/\text{s}$
Unit#1	$12.2\text{ m}^3/\text{s}$
Unit#2	$11.5\text{ m}^3/\text{s}$
Unit#3	$11.4\text{ m}^3/\text{s}$
Unit#4	$11\text{ m}^3/\text{s}$
Unit#5	$11.8\text{ m}^3/\text{s}$
Input Power	977.8 kW
Annual Operating Cost	\$856,578
Capital Cost	\$490,000

5.5. SIMULATION RESULTS

The simulation results show that the scenarios 4, 6 and 7 can meet required face airflows. However after taking into account total costs and expected life of the new infrastructure scenario 6, with use of two underground booster fans and no additional shafts or main fans, is recommended as being the best alternative for further serious consideration to meet ventilation requirements in the five year plan. Table 5.8 shows the contaminant and airflow simulation results.

Table 5.8. Contaminant and airflow simulation results

#	Model	Average CH ₄ level*		Mine Air Quantity m ³ /s	Operating Cost**\$	Capital Cost***\$	Total Cost \$
		1%	0.5%				
1	5 Years Plan with Current Approach	0.63	0.32	205.4	693,270	-----	693,270
2	Add one Intake shaft added	0.61	0.32	210.6	3,564,215	1,464,000	5,028,215
3	Add Two Intake Shafts	0.71	0.36	210.1	3,500,695	3,150,000	6,650,695
4	Add one Exhaust Shaft	0.61	0.33	361.9	7,030,455	2,665,000	9,695,455
5	Add additional Exhaust Fan	0.67	0.35	245.1	6,213,190	490,000	6,703,190
6	Add Two Booster Fans	0.65	0.35	204.3	4,875,095	310,000	5,185,095
7	Add one Booster Fan	0.7	0.36	217	4,282,870	490,000	4,772,870

*The steady state contaminant simulation has been performed based on the requirement of an allowable concentration of methane at each individual working face to identify the path and spread concentration of methane from contaminant source.

** Operating cost: present value of electricity, maintenance costs over 5 years discounted at 10%.

*** Capital Cost: Excavating and fan purchasing and installation fee charges included

5.6. CONCLUSION OF THE SECTION

The current ventilation model of the mine was projected to the mine five-year plan. A feasibility review has been completed of alternatives available to improve workings ventilation as production moves into seams with higher methane content. The scenarios examined alternatives that utilize additional infrastructure such as main ventilation shafts and fans or underground booster fans. Based on the five-year plan model, unit #1 and #3 are the furthest sections in the main west area from the current intake and return shafts and maintaining airflow to them will be difficult unless additional infrastructure is installed.

The following is a review of the research on the various scenario simulations;

1. Scenario #1 expanded the network with the current infrastructure for the next five years and it was determined that due to distance and airway resistance available airflow at working faces is less than the minimum required.
2. Intake shaft #2 has been added to the 1st Main East. Although this alternative maintains the required airflow for Units #2 and Unit #4, the lack of airflow at other faces is obvious.
3. Intake shafts #2 and #3 were added to 1st Main East and 2nd Main West, respectively. The exhausted airflow increased but the airflow on three faces is marginal and there are drawbacks. All airflow from working faces needs to travel a long distance in return airways to be exhausted through the single main fan. Mining areas may have a relatively short life before the additional shafts' locations are bypassed or are no longer in useful positions.
4. Scenario #4 fulfills the airflow requirements at working faces but the total cost is very high.
5. In Scenario #5 a second exhaust fan has been added to the current surface infrastructure. The required airflow is not achieved; moreover the shaft could not handle the increased airflow which caused the second fan to stall.

6. Two booster fans were modeled in 1st Main East Return and 2nd Main West Return in Scenario #6. Scenario 6 meets required face airflows and total cost is a little more than \$5 million.
7. A single booster fan has been added in series in Main North Return in Scenario 7. The airflow on the two faces is marginal.

The conclusion to this study is that scenarios 4 and 6 can meet required face airflows.

However, scenario 4 has a total Present Worth cost of over \$9 million. Scenario 6 meets required face airflows and total cost is a little more than \$5 million. For this reason Scenario 6 is recommended as being the best alternative for serious consideration to meet the mine ventilation requirements in the five year plan.

6. MISSOURI S&T EXPERIMENTAL MINE

6.1. MINE DESCRIPTION

The Missouri S&T Experimental Mine is an underground limestone and dolomite mine located in Rolla, Missouri. The mine is accessed by two adits and has three raises to the surface along with the primary ventilation shaft (Figure 6.1) The two mine portals both have ventilation doors as indicated.

The mine has been upgraded by some slabbing of ribs with blasting for the installation of the two booster fans in the underground workings. The booster fans were installed in bulkheads in a flexible manner so locations could be varied during the project. The airflow and the differential pressures have been monitored across key stoppings and bulkheads as well as the flow quantity through mine airways.

Currently ventilation is provided by the main surface fan of 1.2m diameter. This is a Joy axial vane fan with 30 kW motor (Figure 6.2) set blowing 25.0m³/s airflow at 500 Pa static pressure into the underground workings. The fan passes the air through a 90- degree elbow into the ventilation shaft (Figure 6.3).

6.2. RISK ANALYSIS AND SAFETY CONSIDERATIONS

An assessment of risks has been conducted at Missouri S&T Experimental Mine. The purpose of this assessment was to identify a number of risks which were ranked according to the MIM risk assessment matrix. The matrix considers both the hazard consequence and likelihood of occurrence to arrive at a risk rating index.

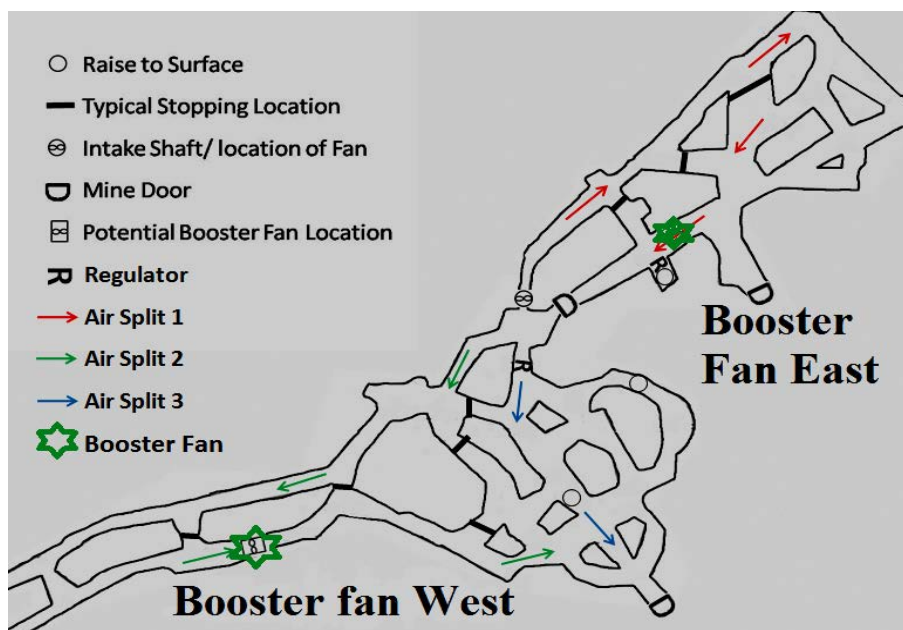

Figure 6.1. The Missouri S&T Experimental Mine portals



Figure 6.2. Main fan infrastructure at Experimental Mine



Figure 6.3. Experimental Mine elbow

6.3. BASICS OF SYSTEM SAFETY

System safety is based on the following general principles:

- *Effective* working depends on the management systems necessary to optimize the use of available resources within the acceptable levels of risk
- *Safe* working depends on the effectiveness of controls and barriers that are designed to prevent undesired energy releases.

There is no such thing as zero risk. In order to identify risk, design and implement appropriate management systems the general approach should be:

- *Holistic* - in that the inter-relationship and dependencies of people, equipment and methods need to be considered within the overall environment.

- *Structured* - within a systematic and analytic framework.
- *Continuous* - throughout the subject life cycle.

6.3.1. Risk Review Procedure. The process of the risk review was as follows:

- Define or model the system.
- Identify hazards associated with the elements defined.
- Assess the risk presented by each identified hazard.
- Identify the system controls, both current and potential.
- Document and process the result

6.3.2. Hazard Identification. Hazards are sometimes referred to as “potential unwanted energy releases” on the basis that it is a release of energy that results in an unsafe condition. During the risk review process a list of energy sources were identified:

- Electrical
- Mechanical
- Radiant
- Chemical
- Gravity

6.3.3. Risk Assessment. Risk was assessed qualitatively by:

- Assessing the consequences in terms of injury damage if the hazard were to occur.
- Assessing the likelihood of the hazard actually occurring if no controls are in place.

The process of the risk review was as follows:

- Define or model the system.
- Identify hazards associated with the elements defined.
- Assess the risk presented by each identified hazards.

- Identify the system controls, both current and potential.
- Document and process the results.

Tables 6.1 and 6.2 show the possible environmental consequences and probabilities, respectively. Table 6.3 shows the risk analysis matrix or final results, and Table 6.4 details the risk assessment analysis results.

Table 6.1. Possible environmental consequences

CONSEQUENCE CATEGORIES LISTING	
PEOPLE	
1	No lost time
2	Minor lost time injury or illness
3	Moderate lost time injury or illness
4	Serious lost time injury or illness
5	Fatality or permanent disability
EQUIPMENT OR ASSETS	
1	less than \$5k damage
2	\$5k to \$10k damage
3	\$50k to \$100k damage
4	\$100k to \$500k damage
5	More than \$500k damage
PRODUCTION/COST/TIME/QUALITY	
1	Less than \$5k delay or rework
2	\$5k to \$50k delay or rework
3	\$50k to \$100k delay or rework
4	\$100k to \$500k delay or rework
5	
Possible environmental consequences	
1	No environmental effects
2	Theoretically could affect the environment or people but unlikely. Public complaints unlikely. Unlikely to affect legal compliance.
3	Water, soil or air likely to be affected, probably in the short term. No damage to flora or fauna. Public complaints unlikely. Prosecution unlikely. Damage cost less than \$5,00.

Table 6.1. Possible environmental consequences (cont.)

4	Water, soil or air affected badly, possibly in the long term. Damage or death to limited numbers of flora or fauna. Public complaints likely. Damage or relocation of archeological/heritage property. Likely prosecution. Damage costs between \$5,00 and \$50,000.
5	Long term damage to water, soil or air. Damage or death to significant numbers of flora or fauna. Many public complaints, possible evacuation. Destruction or archeological/heritage property. Almost certain environmental prosecution. Damage costs exceeding \$50,000.

Table 6.2. Risk analysis probabilities

PROBABILITIES	
A. Almost certain occurrence	Common or reparing
B. Likely happen	Known to occurs, or it has
C. Moderate happing	Could occur, or I've heard of it
D. Unlikely	Not likely to occur
E. Rare	Practically impossible

Table 6.3. Risk analysis matrix

RISK RANKING TABLE					
CONSEQUENCE	1	2	3	4	5
PROBABILITY					
A	11	16	20	23	25
B	7	12	17	21	24
C	4	8	13	18	22
D	2	5	9	14	19
E	1	3	6	10	15
Any score above 10 is considered high					

Table 6.4. Risk assessment analysis results at Missouri S&T Experimental Mine

DESCRIPTION	HAZARD	ASSESSED (Uncontrolled) RISK	CURRENT CONTROLS	CONTROLLED RISK	RECOMMENDED ADDITIONAL CONTROLS	FINAL RISKS
Electrical / Interlock Tests		Probability + Consequences eg E+1=1				
Powering up prior to bulkhead being built	Ignition of gas	E+1=1	<ul style="list-style-type: none"> ▪ Statutory inspections ▪ Mine monitoring ▪ Training 	E+1=1	<ul style="list-style-type: none"> ▪ Ensure the bulkhead prior to powering ▪ Tag out electricians ▪ Commissioning procedure 	E+1=1
Tripping main fans	Ignition of gas	D+2=5	<ul style="list-style-type: none"> ▪ Statutory inspections ▪ Mine monitoring ▪ Training ▪ Tripping of main fan trips underground power 	D+2=5	<ul style="list-style-type: none"> • Detailed briefing of crews • Integrate mine weekly planning into commissioning procedure • Consider alternate duties for personnel underground • Down cast fan to remain running • Developing resource plan allocation for commissioning 	E+1=1

Table 6.4. Risk assessment analysis results at Missouri S&T Experimental Mine (cont.)

	Asphyxiation of personnel	E+1=1	<ul style="list-style-type: none"> ▪ Statutory inspections ▪ Mine monitoring <ul style="list-style-type: none"> ▪ Training ▪ Emergency plan to shut down the fans ▪ Emergency plan for ventilation failure 	E+1=1	<ul style="list-style-type: none"> ▪ Statutory official present at each work area (one at the booster fan area, one with each satellite group) ▪ Vehicles with each group ▪ Communications to control room 	E+1=1
	Loss of production	E+1=1		E+1=1	<ul style="list-style-type: none"> ▪ Schedule out the full program (day 2 & 3 of roster) 	E+1=1
	Loss of water pumps causes flooding booster fans	D+1=2	<ul style="list-style-type: none"> ▪ Sump near to portal ▪ Pump inspections 	D+1=2	<ul style="list-style-type: none"> ▪ Advise Experimental Mine staff to prepare reserve pump 	E+1=1
	Loss of underground power leading to loss of mine dewatering system causing flooding of booster fans	E+1=1	<ul style="list-style-type: none"> ▪ Pump Inspections 	E+1=1	<ul style="list-style-type: none"> ▪ Advise Experimental Mine with regards to water drainage 	E+1=1

Table 6.4. Risk assessment analysis results at Missouri S&T Experimental Mine (cont.)

<ul style="list-style-type: none"> ▪ <i>Staged Commissioning</i> 						
<p>(1)Running main fan Only</p>	<p>Vehicle entering when gas concentrations throughout the length of the tunnel resulting in restricted vehicle access in tunnels</p>	<p>E+1=1</p>	<ul style="list-style-type: none"> ▪ Statutory limits on vehicle operations ▪ Statutory inspections ▪ Predictions of gas levels ▪ Vehicle maintenance ▪ Operation procedures / training ▪ Vehicle protection ▪ Gas monitoring 	<p>E+1 = 1</p>	<p>Advise mine staff of expected gas levels</p>	<p>E + 1 =1</p>
	<p>Loss of underground power leading to loss of mine dewatering system causing of flooding booster fans</p>	<p>E+1=1</p>	<ul style="list-style-type: none"> ▪ Sump near the portal ▪ Pump inspections 	<p>E+1=1</p>	<ul style="list-style-type: none"> ▪ Advise Experimental Mine with regards to water drainage 	<p>E+1=1</p>
	<p>Loss of water pumps causes flooding to panels</p>	<p>D+1=2</p>	<ul style="list-style-type: none"> ▪ Pull miner back ▪ Pump Inspections ▪ Set up panels for power outage 	<p>E+1=1</p>	<ul style="list-style-type: none"> ▪ Advise Exp mine with regards to panel water ▪ Can reset power if required 	<p>E+1=1</p>
	<p>Main fan failure</p>	<p>D+2=5</p>	<ul style="list-style-type: none"> ▪ Maintenance ▪ Electrical interlocks ▪ Statutory inspections 	<p>D+1=2</p>	<ul style="list-style-type: none"> ▪ Pressure Monitoring 	<p>D+1=2</p>

Table 6.4. Risk assessment analysis results at Missouri S&T Experimental Mine (cont.)

(2)Booster fan start up and speed increased to approximately rpm						
▪	Noise induced hearing loss	C+2=8	<ul style="list-style-type: none"> ▪ Hearing protection <ul style="list-style-type: none"> ▪ Legal limit ▪ Sound engineering design or assembler 	D+1=2	<ul style="list-style-type: none"> ▪ Physical check prior to machine turned on that all protection in place 	E+1=1
	Changes in gas and ventilation	E+1=1	<ul style="list-style-type: none"> ▪ Assessment shows no issues has not been addressed above 	E+1=1	<ul style="list-style-type: none"> ▪ Monitoring the tunnel by sensors and gas detectors 	E+1=1
	Physical injury to personnel due to component failure	E+1=1	<ul style="list-style-type: none"> ▪ Training the personnel ▪ Commissioning by manufacture 	E+1=1		
	Economic lose due to delayed commissioning less one month	C+2=8	<ul style="list-style-type: none"> ▪ Commissioning by manufacturer ▪ Talk to the assembler 	D+1=2	<ul style="list-style-type: none"> ▪ Consider restoring main ventilation on Main Fan ▪ Improve leakage control 	D+1=2

Table 6.4. Risk assessment analysis results at Missouri S&T Experimental Mine (cont.)

	Economic lose due to delayed commissioning through component failure more than one month	E+1=1	<ul style="list-style-type: none"> Quality assurance during manufacturing and installation Commissioning by assembler team 	E+1=1	<ul style="list-style-type: none"> Consider restoring main ventilation on main fans Improve leakage control 	E+1=1
	Failure of the bypass doors to close causes delayed commissioning	D+1=2	<ul style="list-style-type: none"> Two Doors Variable speed control on fans which allows pressure across doors to be increased readily 	D+1=2	<ul style="list-style-type: none"> Talk to the technician to check the doors before starting the booster fan 	E+1=1
	(3)Increase Booster Fans at speed (rpm)					
	If Booster fan speed is increased above acceptable levels of ventilation	C+1=4	<ul style="list-style-type: none"> Commissioning procedure to control speed of fan Monitoring trip power around mine Statutory inspections 	D+1=2	<ul style="list-style-type: none"> Limit values to be advised Ventilation survey 	E+1=1
	Potential of recirculation and contamination of intake air	D+1=2	<ul style="list-style-type: none"> Statutory Inspections Ventilation surveys Monitoring and trips Ventilation design 	E+1=1		

Table 6.4. Risk assessment analysis results at Missouri S&T Experimental Mine (cont.)

(4)Run Booster Fans at maximum speed	There are no expected hazards					
Single Booster Fan Operation	All hazards identified above apply to this					
Manual opening and closing of isolation doors	Injury to personnel in vicinity of idle fan	D+1=2	<ul style="list-style-type: none"> ▪ Tagging and isolation ▪ Booster fan shutdown procedures ▪ Pre-start warning ▪ Single booster fan check sheet 	E+1=1	<ul style="list-style-type: none"> ▪ Commissioning procedure 	E+1=1
	Recirculation through idle fan	D+1=2	<ul style="list-style-type: none"> ▪ Tagging and isolation ▪ Isolation door ▪ Single fan check sheet ▪ Environmental monitoring ▪ Alarm and trips 	E+1=1		
	Failure of components due to incorrect start up procedures	C+1=4	<ul style="list-style-type: none"> ▪ Electrical interlocks on brakes, locking pins, ▪ Start up procedure ▪ Tagging and Isolation procedures ▪ Single fan check sheet 	E+1=1		

Several risks of low rating and procedures have been identified. Controls identified for the use of the booster fans were established to minimize the likelihood of hazardous circumstances arising.

6.4. VENTSIM SIMULATION

Ventsim has been written to make the process of ventilation network analysis more user-friendly. It utilizes sophisticated 3D graphics driven by a fully graphical mouse-driven interface.

Ventsim provides the user with the tools to:

- Simulate and provide a record of flows and pressures in an existing mine.
- Perform “what if” simulations for planned new development.
- Help in short term and long term planning of ventilation requirements.
- Assist in selection of types of circuit fans for mine ventilation.
- Assist in financial analysis of ventilation options.
- Simulate paths and concentrations of smoke, dust, or gas.

An advanced version of Ventsim provides additional tools to:

- Undertake thermodynamic analysis of heat, humidity and refrigeration in underground mines.
- Take into account air compressibility for deeper mines.
- Provide tools for analyzing multiple different airway size options, both financially and for establishing ventilation capacity.
- Show dynamic time-based analysis of contaminants and concentrations spreading through a mine from blasting.

- Provide a tool to check for recirculation in mines.
- Simulate Diesel Particulate Matter (DPM) concentrations through a mine.

6.4.1. Ventilation Path Description. The ventilation path at the Missouri S&T Experimental Mine consists of a ventilation shaft, three raises and two portals. The current mine has never been surveyed and so the ventilation model preparation was started by surveying to locate the coordinates of the junctions, splits, stoppings, etc. The coordinates then were imported to an AutoCAD model. The exported DXF file from AutoCAD has been imported to the Ventsim software and the primary ventilation model has been created (Figure 6.4). The air travels down the ventilation shaft and to the east. The Kennedy portal is sealed by a hydraulic gate (Figure 6.5). The air then goes toward the west and exhausts from the Wheeler portal (Figure 6.6).

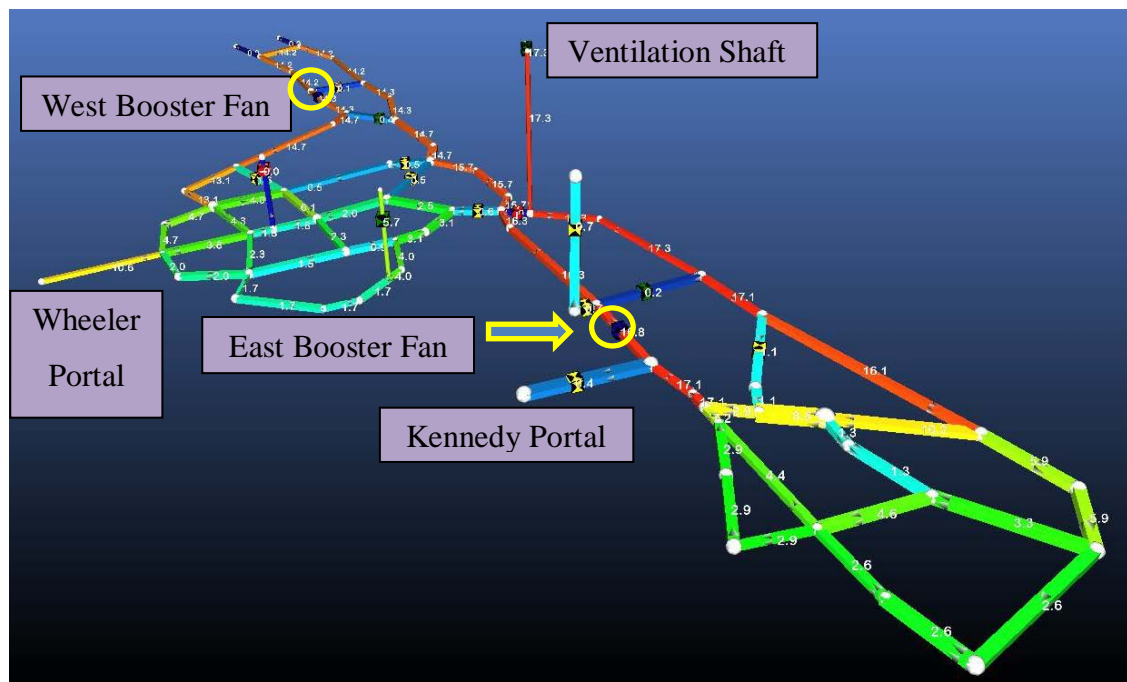

Figure 6.4. Ventsim schematic view of Missouri S&T Experimental Mine



Figure 6.5. Kennedy portal

6.4.2. Model Calibration. Pressure quantity survey results have been used to calibrate the Ventsim model. The survey aimed to acquire data that quantifies the distributions of airflow, pressure and air quality throughout the main airways. The k Atkinson friction factor for each branch has been calculated and inputted into the model. The fan measurements results have also been inputted into the model and the fan curve has been created.

During the surveys at each measuring station, as shown in Figure 6.7 absolute static pressure, air velocity, airway dimensions (height and width) and air temperature (wet bulb/dry bulb) readings were taken and recorded. Reduced Level (RL) and airway length data between the two measuring stations were obtained from mine plans with RL data for the measuring stations from mine surveyors. Ten ventilation stations were established.



Figure 6.6. Wheeler portal

Table 6.5 shows the ventilation survey results at the Experimental Mine. Based on survey raw data, air quantity and static pressure loss between each measuring stations were calculated. As absolute static pressures were measured, calibration for differences in elevation and air density between measuring points was necessary to obtain the static pressure loss.

The airway resistance, R , was then calculated knowing both the air quantity and the pressure loss. From that, friction factor, K , was obtained by knowing the airway length, perimeter and cross sectional area.

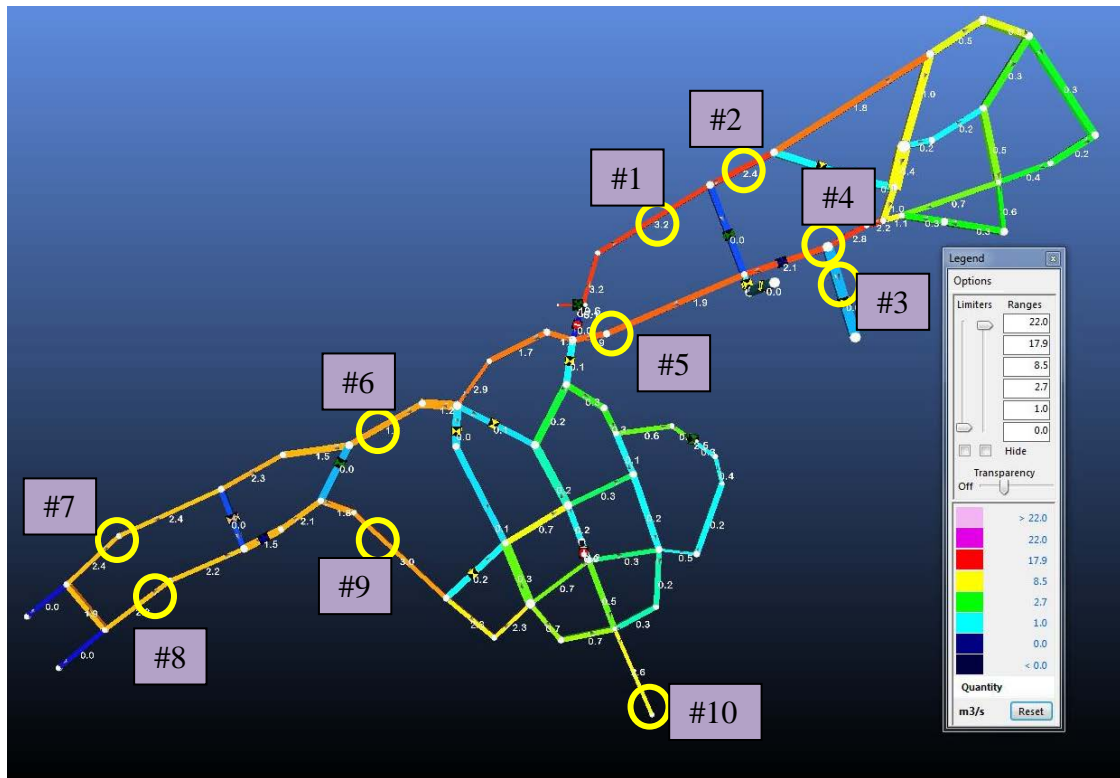

Figure 6.7. Ventilation stations at Experimental Mine

Based on the pressure and quantity survey results, an assessment of the current ventilation system was undertaken. A quantity balancing was carried out based on Kirchhoff's Laws.

The total intake air quantity measured at the Experimental Mine was $19 \text{ m}^3/\text{s}$ through the downcasting ventilation shaft. The total exhaust air quantity was measured as $11.9 \text{ m}^3/\text{s}$ from the Wheeler portal and $5.5 \text{ m}^3/\text{s}$ from Raise #2. This represents a difference of about 9.1% in volumetric flow rate which is acceptable as this is within the accuracy of the instruments used. The Kennedy portal door was closed and leakage was measured at 0.02 m/s or $0.26 \text{ m}^3/\text{s}$ which was considered negligible.

Table 6.5. Ventilation survey results, both booster fans excluded

Pressure Quantity Results (Both Booster Fans Excluded)																	
#	RL m	X-area		P m	Area m ²	L m	RL Adj Pa	Ps kPa	ΔP		Ps adj Pa	Temp		V m/s	ρ kg/m ³	R Ns ² /m ⁸	K Ns ² /m ⁴
		H	W						kPa	Pa		wb	db				
1	301.5	2.1	2.8	9.7	5.8	10.5	5.86	98.64	0.01	10	15.86	10.0	15.0	3.3	1.195	0.04567	0.0786
2	302.0	2.1	2.5	9.3	5.3	23	4.71	98.63	0	5	9.71	9.4	14.2	3.4	1.202	0.11461	0.3027
3	302.4	2.4	5.3	15.5	12.8	5.27	-7.10	98.63	0	5	2.10	10.8	11.9	0.02	1.206	0.02456	0.4259
4	301.8	2.6	3.4	11.9	8.7	20.1	- 14.19	98.62	0.03	30	15.81	10.3	11.9	2.1	1.205	0.05196	0.1014
5	300.6	2.4	2.6	10.1	6.4	29	12.94	98.59	0.01	10	22.94	10.0	12.2	2.6	1.199	0.08521	0.0810
6	301.7	2.4	2.8	10.4	6.7	34	4.68	98.58	0	5	9.68	10.6	15.0	2.4	1.193	0.04415	0.0234
7	302.1	2.1	2.1	8.3	4.3	22.5	1.17	98.58	0.01	5	6.17	10.8	15.0	3.1	1.193	0.03745	0.0150
8	302.2	2.2	1.8	8.1	4.1	38	- 14.09	98.57	0.11	110	95.91	11.1	15.0	3	1.197	0.50255	0.2069
9	301.0	2.1	3.0	10.3	6.4	37	- 41.26	98.46	0.01	10	31.26	11.7	12.8	2.4	1.202	0.16824	0.0696
10	297.5	2.1	1.9	8.0	4.0			98.45		0		11.7	12.2	3	1.203	0.00000	

Details of quantity balancing for various survey locations in the Experimental Mine are shown in Table 6.6. Quantities obtained through quantity balancing using Kirchhoff's Laws compared well at an average 4.1 percent difference with measured quantities obtained from pressure and quantity surveys conducted.

Table 6.6. The comparison of predicted Ventsim Visual and experiments results

Vent Station	Q (m ³ /s)		% Quantity Difference
	Measured Quantity at Mine	Predicted Ventsim Results	
1	19.0	17.8	6.9
2	18.2	17.8	2.1
3	0.3	0.3	0.0
4	18.3	17.3	5.7
5	16.7	17.4	4.3
6	16.1	15.8	2.0
7	12.2	12.9	4.0
8	12.2	12.9	0.0
9	15.4	15.8	2.5
10	11.9	10.5	13
Average % Difference between measured and Ventsim quantities			4.1

In general, larger discrepancies are observed with low velocity measurements. This could be contributed to the following factors:

- Limitations of the instruments used,
- Measurement errors such as misreading the instruments,
- Disturbance of airflow during measurements such as traffic upstream or downstream of the measuring stations or in the main decline nearby.

To obtain a better representation of the real ventilation network, equivalent resistance values were obtained by trial and error after repeating runs of the network simulations. Some values were obtained by using the newly incorporated orifice calculation feature in Ventsim airway editing functions. By giving the size of opening of leakage paths, an equivalent resistance was calculated.

Ventsim can be set to calculate shock losses using the equivalent length method, or the shock factor (X) method. Shock loss calculations are necessary to estimate pressure loss due to air turbulence caused by a change in airway direction, a junction or a change in airway size. Note that changing this value in an existing network will result in Ventsim requesting to recalculate the shock losses using the alternative system.

The equivalent length method requires the user to estimate an equivalent extra airway length required to approximate pressure loss due to shock. The shock factor (X) method uses a calculated factor derived from both empirical and calculated changes in airway areas and velocities. Both methods are described in any number of ventilation texts.

Once the method is set, the Edit Box will require an appropriate shock loss value for each airway. The Edit Box can accept a manually entered number, but also has a number of preset values, as well as an AUTO function which will force Ventsim to attempt to calculate a shock loss factor or an equivalent length (Ventsim 2012).

The Experimental Mine Ventsim model has been constrained by Shock Loss factor and is shown in Figure 6.8.

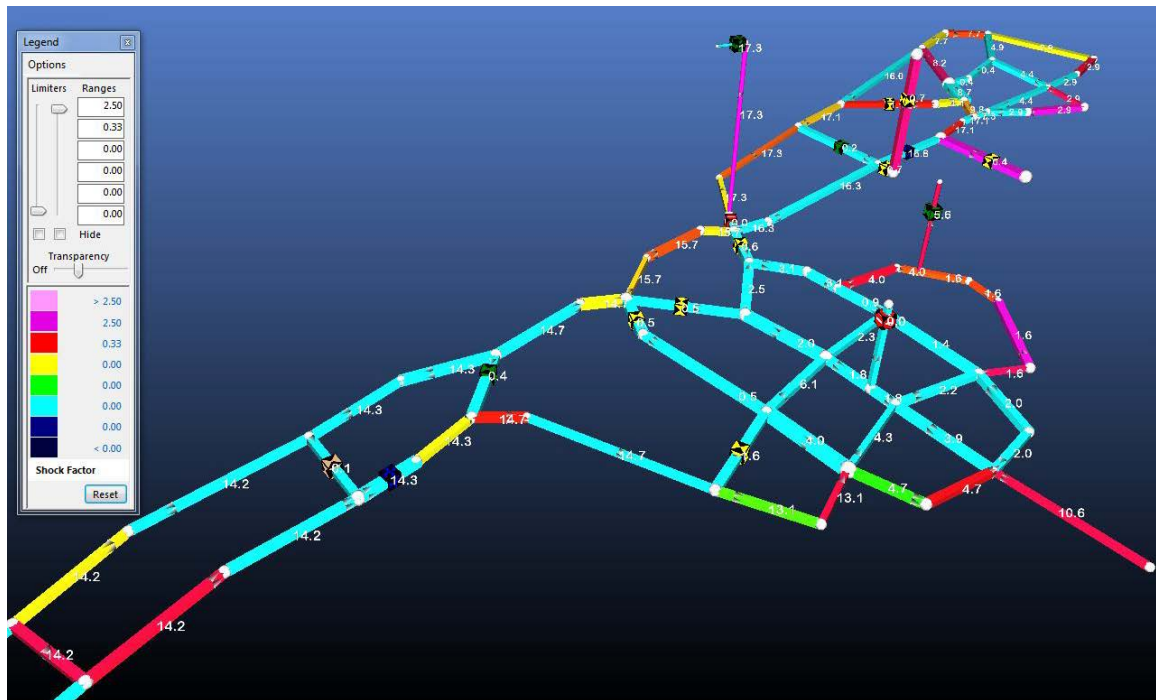

Figure 6.8. Shock loss at Experimental Mine model

6.4.3. Booster Fans Selection. The estimation of a booster fan's operating condition by the measurement of the static pressure across the bulkhead is rarely done correctly. It is common for ventilation textbooks to show that the static pressure taken across a booster fan mounted in a duct system is equal to the total pressure generated by the fan (Krog R. B, 2002). Such a simplification is correct, but is usually incorrectly applied to actual mining situations, as it was designed to be used primarily with Heating Ventilation Air Conditioning (HVAC) systems.

When velocity pressure is constant there is no expansion/contraction shock loss in the fan assemblage. Booster fans mounted in bulkheads with large aspect ratios in cross sectional area and free discharge can have very high shock losses that drastically reduce the overall efficiency of the fan assemblage. The fans still operate at a high efficiency but the effective static pressure

generated across the bulkhead is reduced by the large amount of pressure being consumed through entrance and exit shock losses.

Once the fan duties are specified, the next step is to determine the type, size and number of fans for the system. Here, the objective is to select a fan or set of fans that meets the flow requirements and has high efficiency. There are two basic types of booster fan installations: cluster fans and custom built fans (Burrell, 1995). Cluster fans consist of several small axial fans installed in series or parallel arrangements. They are reasonably cheap and readily available. They have a common problem in their low efficiencies, which is usually less than 60%. On the other hand, custom built fans are designed to develop the required pressures at high efficiencies (greater than 80%) for a wide range of flow rates. They are equipped with inlet and outlet cones, fixed guide vanes, and self-closing doors. They can be of axial flow, radial flow, or mixed flow type. To reduce leakage and recirculation, these are installed in concrete bulkheads and equipped with fan condition monitors. Usually, they have higher capital cost than the cluster fans, but reasonably low operating costs.

Using Spendrup Fan's catalog (2011), the booster fan at the Experimental Mine Fan series 112-040-1200 should operate to the following characteristics curve is shown in Figure 6.9. Blade setting #4 is being used in this simulation to match the surface fan quantity throughput.

A booster fan must be designed considering the airflow requirements of a working district, the life of the district, and operational constraints. This requires the evaluation of alternate solutions, conducting of simulation exercises, and evaluation of the simulation results against the minimum requirements.

The selected fan should be durable, easy to maintain, and efficient for a wide range of fan duties. If used in coal mines, the fan components must be constructed from fireproof materials. It must be installed in a concrete bulkhead and equipped with airlock doors, self-closing or anti-

reversal doors, safety barriers, and a monitoring system. Before commissioning, the fan must be tested at no-load and full load conditions.

During each test, parameters such as vibration, bearing temperature, blade tip clearance, and power consumption should be measured and compared against allowable limits (Calizaya, 2009).

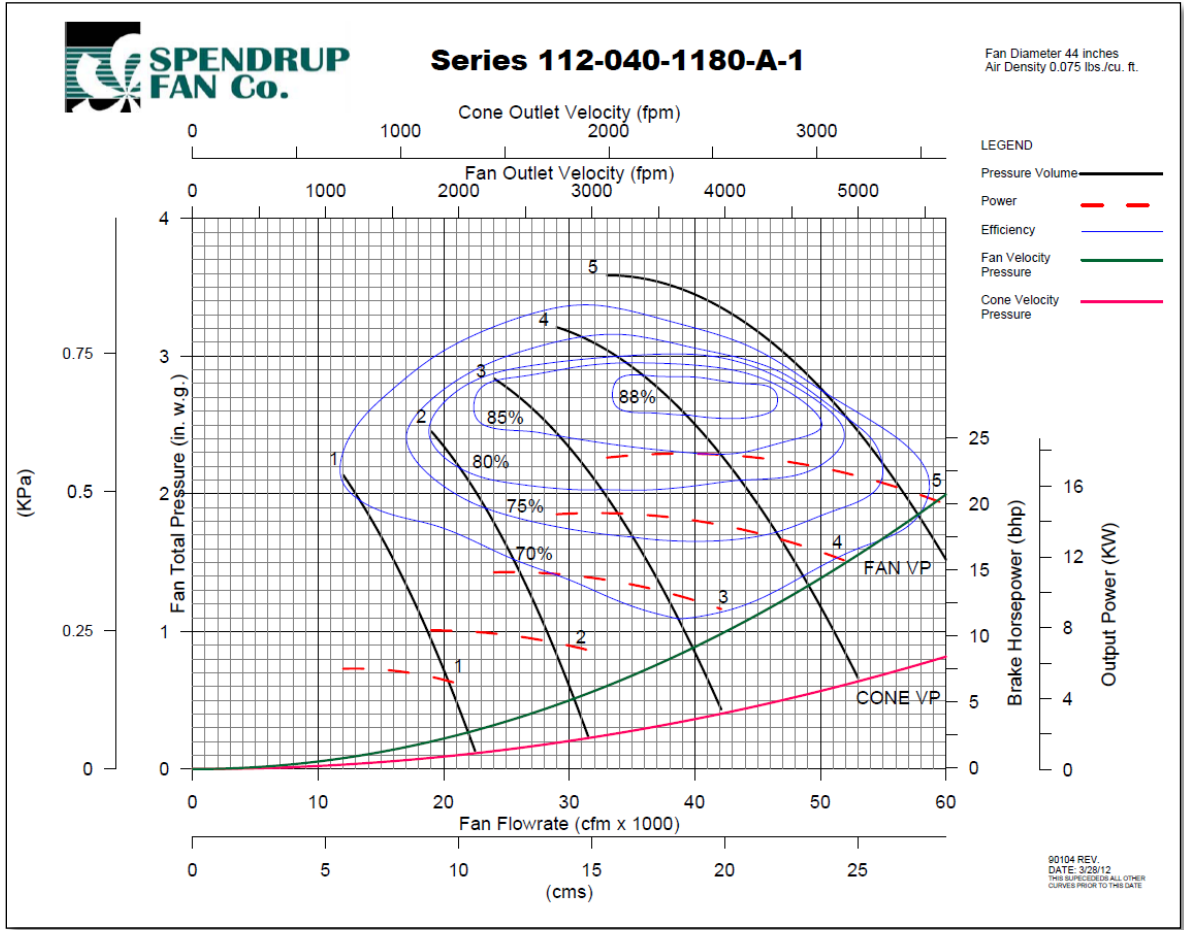

Figure 6.9. Fan characteristics curve

6.4.4. Simulation Results. The main aim of the Experimental Mine ventilation modeling is to ensure that required air quantities can be achieved in all sections with the lowest cost. Station 7 is the working face that is located at the farthest distance from the main surface fan. As a simulation exercise a “need” has been created to increase the volume flow rate at station 7. The amount of $12.2\text{m}^3/\text{s}$ has been measured at this station without use of booster fans. Simulations have been conducted incorporating use of the two identical booster fans to improve the volume flow rate at this station.

The simulation examines four scenarios, with results shown in Table 6.7.

The first scenario shows the current ventilation conditions. In this layout Raises #1 & #2 are considered to be open and Raise #3 fully closed. The results show that the amount of the air in the east part of the mine at station 7 is inadequate due to the leakage occurring through stoppings.

The second scenario has been conducted to study the combination of the Main and East Booster fans. The results show that the booster fans maintain the maximum quantity at the west and increase the amount at the east. Moreover they slightly increase operating cost. In this scenario the resistances of all stoppings and doors has dramatically increased to avoid the recirculation. The experimental and simulation results are shown in Table 6.8.

The third scenario studies the effect on the West Booster operating in series with the Main fan. This scenario maintains the airflow at station 7 as well as other stations. The operating point shows that the fan produces the highest quantity of the air with very low pressure. According to the manufacturer’s fan curve there are six blade angles available which by reducing the angle from 6 to 4 will shift the operating point up the curve. Similarly in this scenario the resistances of all stoppings and doors have been increased to avoid the possibility of recirculation. The experimental and simulation results are shown in Table 6.9.

The combination of two booster fans in series with the Main fan has been investigated. The airflow has been maintained, however the efficiency is similar to the third scenario. The

operating cost dramatically increases. In this case both booster fans are operating at the extreme of the characteristic curve operating points of high quantity and low pressure as calculated by use of Ventsim Visual. The experimental and simulation results are shown in Table 6.10.

6.5. CONCLUSIONS TO THE SECTION

Use of booster fans can lead to lower operating electricity power costs as they augment mine fan power and do not waste energy as occurs with use of mine regulators. As such they are a good alternative approach to balancing or controlling airflow through mine parallel splits. They may extend “life of mine” fan duty as they augment mine fan power. The booster fan allows deferral of installation of a new ventilation shaft or other major capital facility.

At the Experimental Mine results show that the combination of West booster fan and main fan will increase the volume flow rate at station 7. The last scenario (Main + both boosters) will also fulfill the airflow requirement at station 4 but the power consumption is in excess of the third scenario. The second scenario (Main + East booster) does not meet the air requirement at station 7.

The conclusion is that the third scenario is the best option for this study and may be the best solution for optimizing the network.

Recirculation and leakage are the result of usage of the booster fan in the ventilation network. During the conducting of the pressure and quantity survey, leakage through nearby stoppings was noticeable. The constant maintenance of stoppings is highly recommended. Air leakage will increase ventilation cost in underground mines.

Table 6.7. Ventsim results for different fan alternatives

#	Alternatives	Fan Duty						Stations Quantity			Power (kW)
		Pressure (Pa)			Quantity (m ³ /s)			(m ³ /s)			
		Main	East Booster	West Booster	Main	East Booster	West Booster	1	7	10	
1	Main Fan	246.9	*	*	19	*	*	17.7	12.9	10.5	6.7
2	Main + East Booster	161.5	112.7	*	18.8	19.2	*	18.5	15.8	11.7	8.0
3	Main + West Booster	212.9	*	81	18.2	*	19.7	18.8	19.5	11.9	7.5
4	Main + Both Boosters	148.9	91	76	19.1	19.5	19.8	19.8	21.3	10.7	9.9

Table 6.8. Scenario 2, experimental and Ventsim Visual results

Scenario 2, Main Fan + East Booster Fan														
#	Perimeter	Area	RL Adj	Ps	ΔP		Ps adj	V	w	R	K	Q (m ³ /s)		% Difference
	m	m ²	Pa	(kPa)	(kPa)	Pa	Pa	(m/s)	Kg/m ³	(Ns ² /m ⁸)	(Ns ² /m ⁴)	Experiment	Ventsim	
1	9.7	5.8	5.86	98.64	0.01	10	15.86	4.4	1.195	0.03996	0.0687	20.0	18.5	8.1
2	9.3	5.3	4.72	98.63	0	0	4.72	3.7	1.202	0.04589	0.1212	19.8	19.1	3.5
3	15.5	12.8	-7.10	98.63	0	0	7.10	0.04	1.206	0.06768	1.1737	0.5	0.5	0.0
4	11.9	8.7	-14.19	98.63	0	0	14.19	2.3	1.206	0.03822	0.0746	20.0	19.6	2.2
5	10.1	6.4	12.94	98.63	0.01	10	22.94	2.9	1.199	0.06796	0.0646	18.6	18.2	2.2
6	10.4	6.7	4.68	98.62	0	0	4.68	2.7	1.193	0.01600	0.0085	18.1	16.4	10.5
7	8.3	4.3	1.17	98.62	0.01	10	11.17	3.2	1.193	0.04312	0.0172	16.0	15.8	1.3
8	8.1	4.1	-14.09	98.61	0.1	100	85.91	3.4	1.197	0.30656	0.1262	16.1	15.8	1.9
9	10.3	6.4	-41.28	98.51	0.01	10	31.28	2.7	1.202	0.13570	0.0561	17.3	16.4	5.7
10	8.0	4.0		98.5		0		3.3	1.204	0.00000		13.1	11.8	10.6
Average % Difference between measured and Ventsim quantities														4.6

Table 6.9. Scenario 3, experimental and Ventsim Visual results

Scenario 3, Main Fan + West Booster Fan														
#	Perimeter	Area	RL Adj	Ps	ΔP		Ps adj	V	w	R	K	Q (m ³ /s)		% Difference
	m	m ²	Pa	kPa	kPa	Pa	Pa	m/s	Kg/m ³	Ns ² /m ⁸	Ns ² /m ⁴	Experiment	Ventsim	
1	9.7	5.8	5.86	98.52	0.01	10	15.86	3.5	1.194	0.03848	0.0662	20.2	18.8	7.4
2	9.3	5.3	4.71	98.51	0.02	20	24.71	3.8	1.200	0.23521	0.6212	20.3	18.7	8.6
3	15.5	12.8	-7.09	98.49	0	0	7.09	0.02	1.205	0.07606	1.3190	0.2	0.2	0.0
4	11.9	8.7	-14.17	98.49	0.02	20	5.83	2.2	1.204	0.01534	0.0299	19.2	17.8	7.6
5	10.1	6.4	12.92	98.47	0.02	20	32.92	3.1	1.197	0.07675	0.0729	19.9	20.0	0.5
6	10.4	6.7	4.67	98.45	0	0	4.67	3.2	1.191	0.01233	0.0065	21.5	20.0	7.4
7	8.3	4.3	1.17	98.45	0.02	20	21.17	4	1.191	0.06954	0.0278	17.3	19.5	11.2
8	8.1	4.1	-14.08	98.43	-0.01	-10	24.08	4.3	1.196	0.06216	0.0256	17.5	19.5	10.5
9	10.3	6.4	-41.26	98.44	0	0	41.26	3.4	1.202	0.13270	0.0549	21.8	20.0	9.2
10	8.0	4.0		98.44		0		3.4	1.203	0.00000		13.5	11.9	13.0
Average % Difference between measured and Ventsim quantities														7.5

Table 6.10. Scenario 4, experimental and Ventsim Visual results

Scenario 4, Main Fan + Both Booster Fan														
#	Perimeter	Area	RL Adj	Ps	ΔP		Ps adj	v	w	R	K	Q (m3/s)		% Difference
	m	m ²	Pa	kPa	kPa	Pa	Pa	m/s	Kg/m ³	Ns ² /m ⁸	Ns ² /m ⁴	Experiment	Ventsim	
1	9.7	5.8	5.87	98.7	0.02	20	25.87	3.7	1.196	0.05795	0.0997	21.3	19.8	7.8
2	9.3	5.3	4.72	98.68	0.01	10	14.72	3.9	1.202	0.12855	0.3395	20.8	19.5	6.9
3	15.5	12.8	-7.10	98.67	0.01	10	2.90	0.05	1.207	0.02746	0.4761	0.6	0.6	0.0
4	11.9	8.7	-14.20	98.66	0.03	30	15.80	2.3	1.206	0.04119	0.0804	20.0	20.0	0.1
5	10.1	6.4	12.94	98.63	0.03	30	42.94	3	1.199	0.11857	0.1127	19.2	19.5	1.3
6	10.4	6.7	4.68	98.6	0.02	20	24.68	2.8	1.193	0.07014	0.0371	18.8	20.8	9.6
7	8.3	4.3	1.17	98.58	0.02	20	21.17	4.3	1.193	0.05678	0.0227	18.6	21.3	12.6
8	8.1	4.1	-14.09	98.56	0.01	10	4.09	4.9	1.197	0.01065	0.0044	19.9	21.3	6.6
9	10.3	6.4	-41.28	98.55	0.1	100	58.72	3	1.202	0.23666	0.0979	19.3	20.8	7.4
10	8.0	4.0		98.45		0		3.1	1.203	0.00000		12.3	10.7	14.6
Average % Difference between measured and Ventsim quantities														6.7

7. BOOSTER FAN EXPERIMENTS AT MISSOURI S&T MINE

7.1. BOOSTER FAN INSTALLATION

7.1.1. Standard Booster Fan Installation. Booster fans are installed in concrete bulkheads sealed with plaster. When the fan is switched on, the pressure on the delivery side is higher than on the intake side. The difference is the effective fan pressure added to the air stream.

Figure 7.1(A) shows a booster fan sited within a main drift and two airlock doors in a bypass drift. This pressure is used to increase the airflow rate in the district. Bulkheads should be sealed from the high pressure side and the doors affixed with rubber seals. The doors should be designed in such a way that they are always kept closed when the fan is running and open when the fan is down.

Figure 7.1 (B) shows two axial fans and a man door in parallel arrangement. The man door is an airtight chamber with two manual doors which are kept closed by the fan pressure. The fans are equipped with inlet and outlet cones to reduce shock losses and self-closing doors to avoid flow recirculation when one fan stops while the other is still running. Another detail shown in this Figure is the fan spacing. The minimum distance between equal-sized fans should be equal to or greater than one fan diameter (Calizaya, 2009).

7.1.2. Mechanical Site Preparation. The booster fans needed to be prepared on the surface before being taken underground and installed.

7.1.3. Booster Fans Transportation. Each booster fan was mounted on a skid on the surface and transported to the Mine and then underground. The skid construction utilized traditional oilfield/mining skid design. Two 15cm channel iron runners were used for the outer frame with heavy wall 15 by 8cm box tubing making up the center cross members (Figures 7.2 and 7.3). Schedule eighty (80) pipe 9mm in diameter with capped ends was used for the end cross members (Figure 7.4).

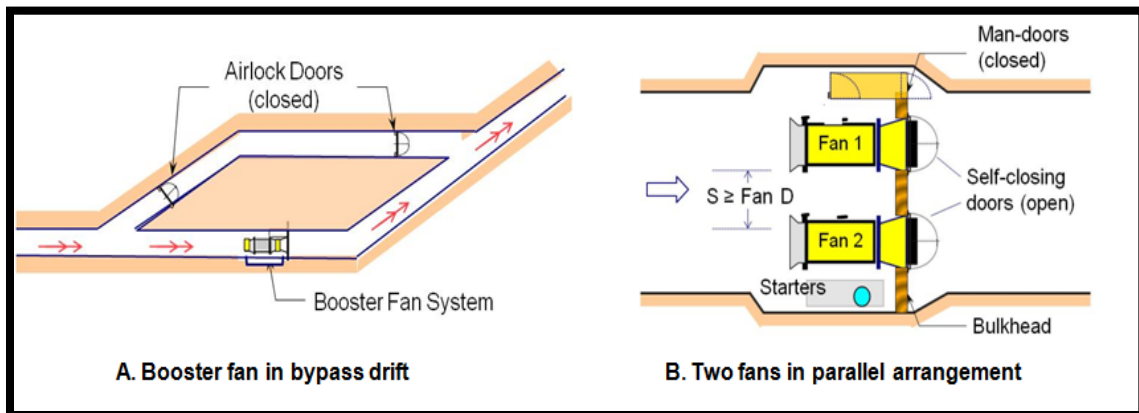

Figure 7.1. Installation booster fans (Calizaya, 2009)



Figure 7.2. Channel iron runners



Figure 7.3. Box cross member

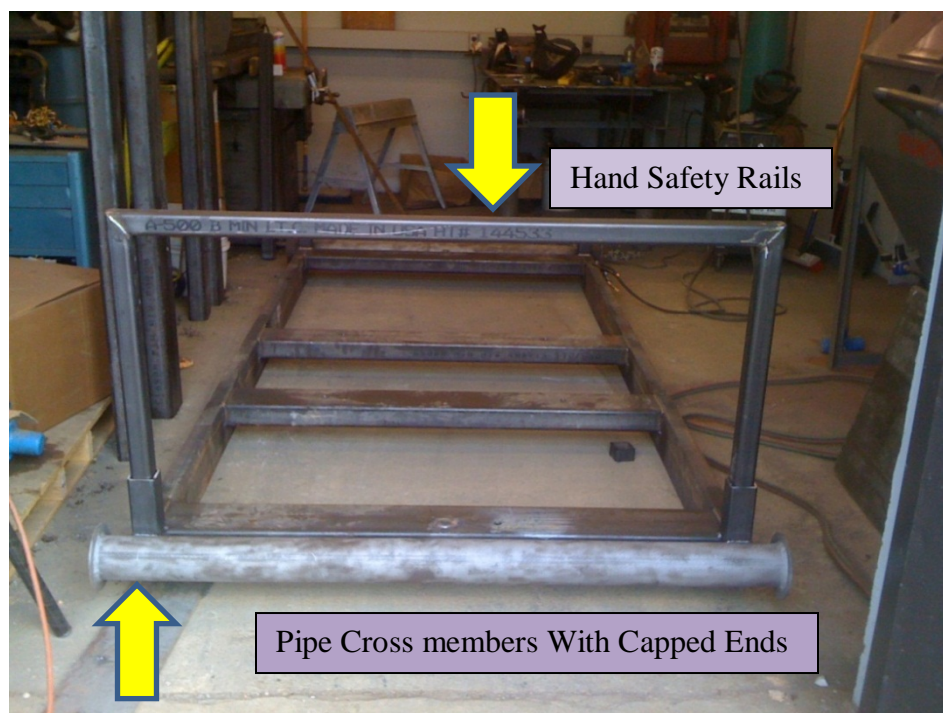

Figure 7.4. View of the skid

The channel iron ends were reconfigured with an upward sloping design where they attached to the pipe cross members enabling them to be moved across uneven surfaces with little resistance. The side rails were also fitted with two “D” lashing rings per side to be used for moving and/or transporting purposes (Figure 7.5). The rails were also constructed with three anchoring provisions per side on the bottom flange so they could be attached to the mine floor bolts.



Figure 7.5. Side rails with D lashing rings

The mounting holes for final assembly of fan to skid were all pre drilled, tapped and threaded wherever necessary before initial fabrication began.

Welding was carried out using traditional Metal Inert Gas (MIG) practices with mild steel wire at approximately 125-130 degrees with the majority being fillet welds. Hand safety rails that doubled as fan guards on each end were constructed of 5 by 5 by 5mm box steel (Figure 7.6). These were designed to be removed during testing procedures.

Upon completion, all parts were industrial powder coated to resist corrosion from the harsh underground environment. All mounting hardware used for assembly i.e. bolts, nuts, flat and lock washers were of grade five quality with a zinc coating.



Figure 7.6. Completed skid with the mounted booster fan

The Fan/Skid Assembly was also designed with a removable lifting axle and swiveling fork pocket system (Figure 7.7). This enables the assembly to be raised above ground level up to 15cm on one end with the lift axle.

The other end can then be lifted with a skid loader or forklift and pushed or pulled to the desired location in the mine. When the location is determined, the skid assembly is lowered and by removing two 2.5cm bolts, the lifting axle and fork pockets are removed and the skid is ready to be anchored (Figure 7.8).

This design offers a very strong and rigid platform that is protective of the fan assembly, easy to transport and simplifies the leveling process.



Figure 7.7. Removable lifting axle assembly



Figure 7.8. Booster fan transportation

7.1.4. Bulkhead Construction. The booster fan bulkheads were built to withstand blasting in the Experimental Mine. They were designed with a the fan on one side and a door on the other to facilitate access. The following are the steps that were undertaken as part of the process of putting the bulkheads in the mine. As a first step some blasting of ribs was undertaken at a number of “narrow” underground points to ensure passage of the 112cm diameter booster fans as shown in Figure 7.9. In addition the two selected sites for the fans required some drift widening. Ten blasts including drilling, blasting and scaling was undertaken over three weeks.

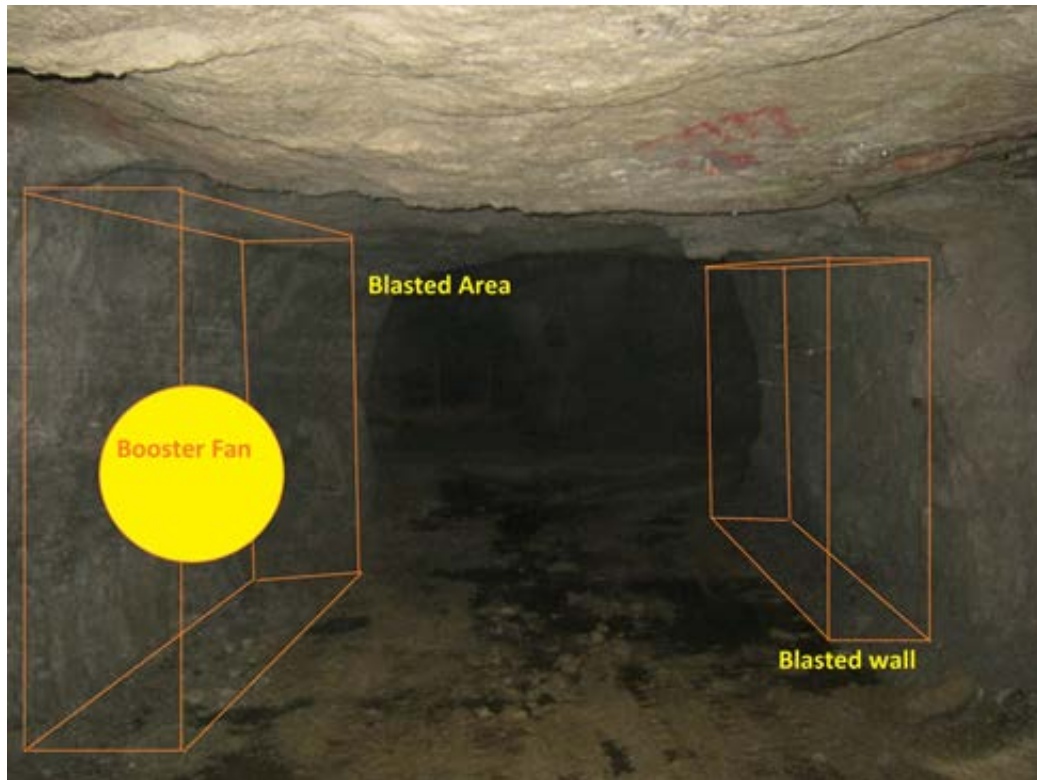

Figure 7.9. East booster fan location preparation

The bulkhead design used in the mine must withstand air blast and the underground elements such as humidity. The decision has been made to use treated wood for the timbers. Over many years Jack Kennedy Company metal stoppings have been installed with support from fully treated 15 by 15cm treated timbers. To hold the timbers in place lead anchors have been hammered drilled into the mine rib and back (Figure 7.10). The 2cm in diameter all thread bolts holds the timbers in place with at least three all thread bolts on each side.

All the timbers are squared with each other along with the top timbers at 90 degrees. To lock the timbers together 6mm steel plate have been used on each side and lag screw the timbers together (Figure 7.11).



Figure 7.10. Anchoring the frame to the back of the mine

The horizontal 15 x 15cm timbers were used across the top of each bulkhead. Fans are locked between side timbers and the middle timbers. The opening over the top and the along sides of the fans were blocked off using 20mm treated plywood screwed to the timbers as shown in Figure 7.12).

The remaining openings of the bulkhead were filled with Kennedy stoppings and Kennedy doors. Cementitious mixtures and expanded foam sprays were used to seal cracks and leakage paths in bulkheads and stoppings to reduce leakage. To stop any movement skids have

been bolted to the ground with wedge head anchor bolts to reduce vibrations generated by the booster fans (Figure 7.13)



Figure 7.11. Steel plate attached to frame pieces



Figure 7.12. Blocking the area around the booster fan with 20mm plywood

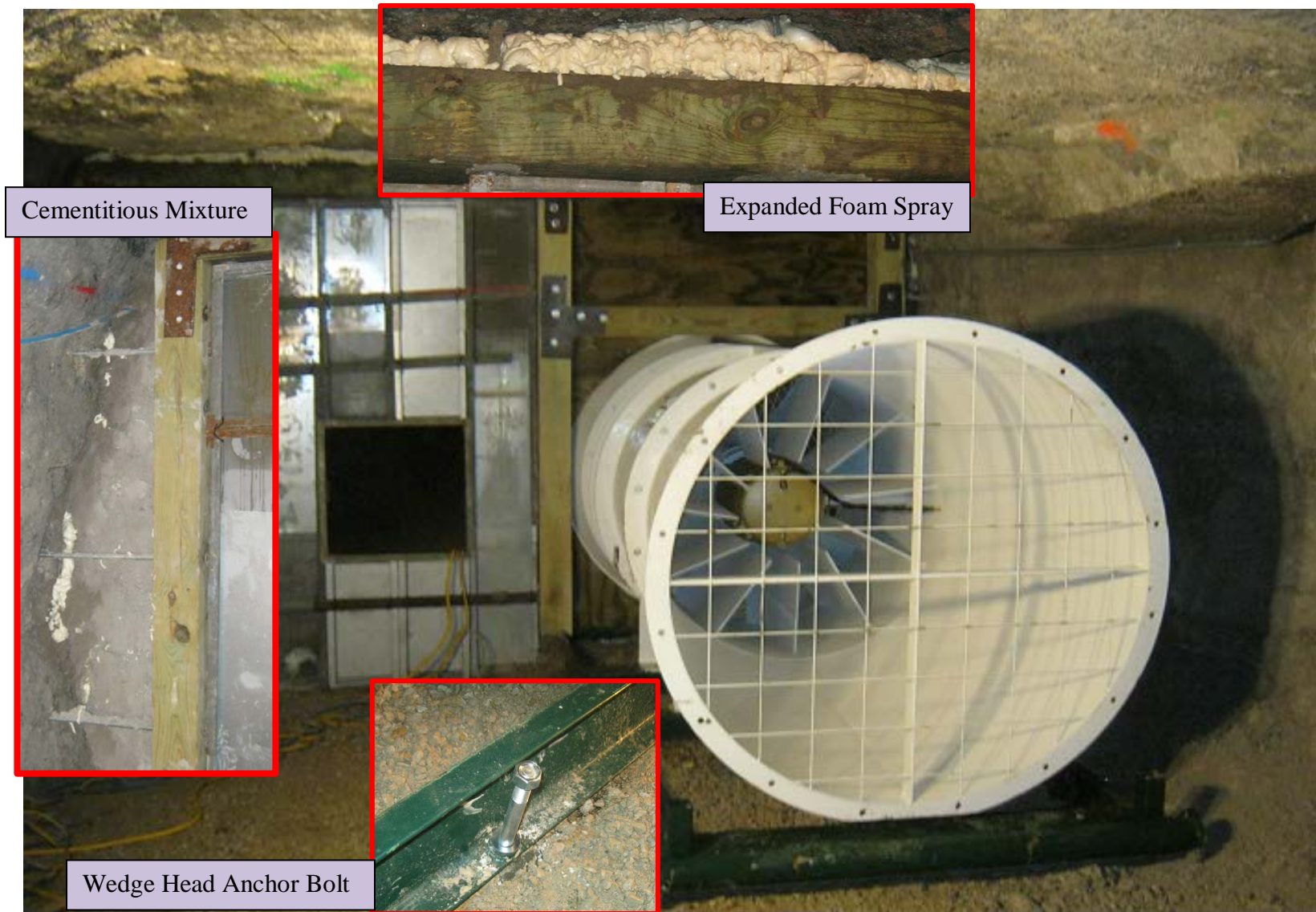

Figure 7.13. Completed bulkhead view

7.1.5. Electrical Circuit Description. Each booster fan is driven by a 12kW three phase 460V motor that loads the circuit by approximately 20A. Safety issues mean a requirement of a total of 60A including 1.5 safety factor (Figure 7.14).

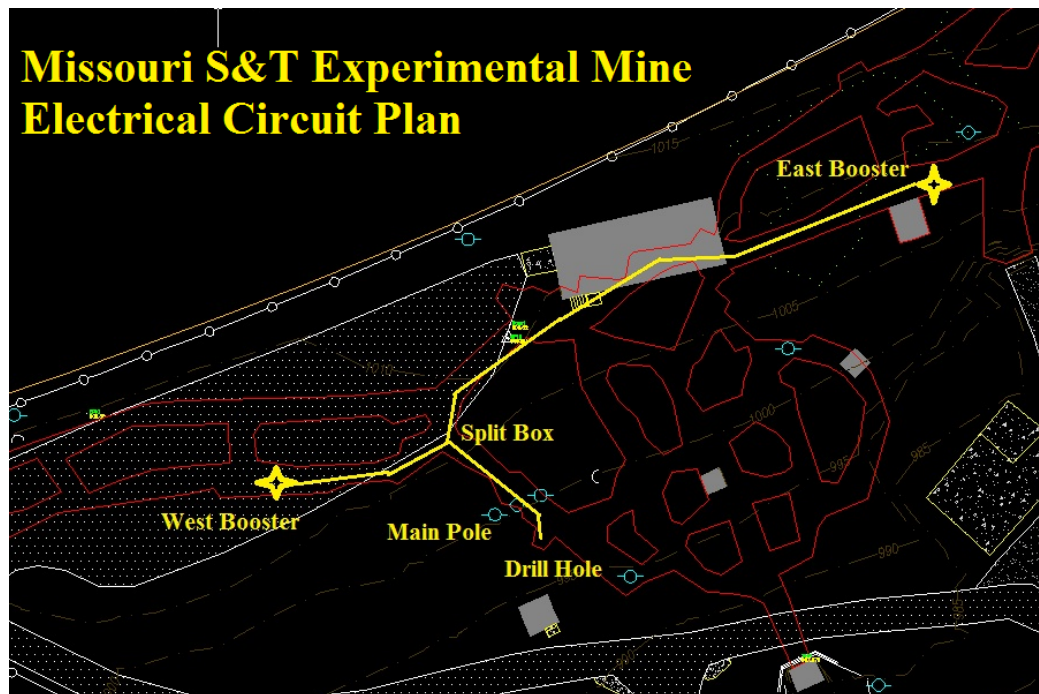

Figure 7.14. Missouri S&T Experimental Mine electrical circuit plan

A 76 mm hole was drilled through the rock to pass the fans' power cable from the power pole underground as shown in Figure 7.15. A safety "kill" switch has been installed on the power pole. The switch will shut down both fans in case of emergency.



Figure 7.15. Surface preparation to pass the power cable underground

Additional safety switches have been installed underground. Two #10 wires pass into the mine to energize both fans. A split box breaks the circuit in two. Conduits of 20mm and 50mm have been used to run the wire throughout the mine. The conduits have been anchored to the roof with rock screws as shown in Figure 7.16.

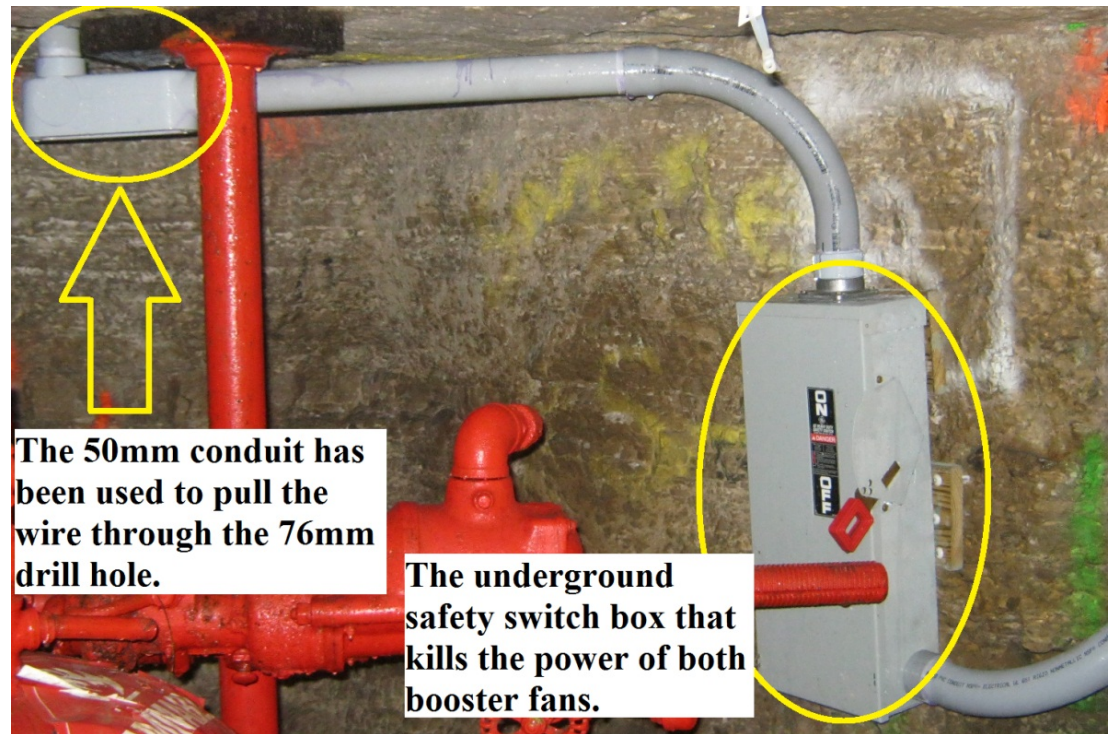

Figure 7.16. The underground safety switch

The electrical components have been installed next to the fans. The power cable enters the main switch box which contains fuses, circuit breakers, contactors and starter. A Variable Frequency Drive (VFD) has been installed for each fan. The VFDs have been mounted in separate boxes next to the switch boxes.

Low power resistance coils have been wired and placed in steel boxes to keep interior temperatures above the dew point. All boxes have been rock drilled to rib in the mine.

Figures 7.17 and 7.18 show the completed West and East bulkheads at the Experimental Mine.

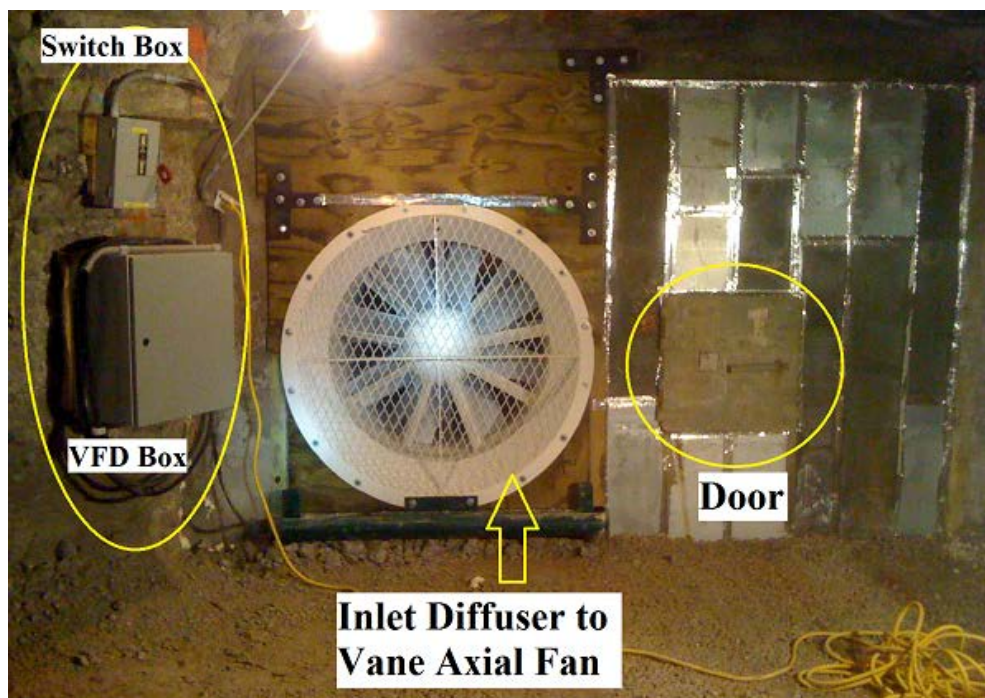

Figure 7.17. Electrical components at the West booster fan



Figure 7.18. East booster fan installed in bulkhead

8. COMPUTATIONAL FLUID DYNAMICS (CFD) MODEL

8.1. INTRODUCTION

Three-dimensional fluid flow models are the subject of fluid mechanics, especially fluid dynamics. Fluid mechanics can be mathematically complex and there are no general analytical schemes for solving nonlinear partial differential equations contained in the governing equations for available fluid flow models.

To resolve engineering problems, one approach is to simplify the governing equations and boundary conditions. Only limited cases can be solved, however, because too much simplification produces useless or unreliable results.

Another approach is to use numerical methods and algorithms, with the help of a computer, to get the approximate solutions. This approach, called the computational fluid dynamics method, was used in this research to study leakage through stoppings and recirculation.

Current mine ventilation planning programs such as Ventsim, VnetPC, and VUMA use Hardy-Cross based numerical simulators to simulate one-dimensional fluid flow of air or a mixture of air and airborne contaminants.

While these one-dimensional fluid flow simulators can effectively simulate the airflow network for normal mine ventilation planning, they are not always best suited to analyze leakage and recirculation patterns through stoppings, regulators and doors. For this situation, the use of three-dimensional fluid flow models provides more useful quantitative data to analyze the problem.

8.2. PROBLEM STATEMENT

To effectively distribute fresh air underground, underground mines must have a sound ventilation system, well-constructed ventilation controls and a rigorous maintenance program to

ensure the effectiveness of these structures. One of the major problems is that possibly only half of the air entering the mine actually gets to working areas. The rest of it simply short-circuits directly to return airways. Individual air leaks are difficult to detect and expensive to maintain. Cumulative air losses from poorly maintained stoppings and overcasts will cause a shortage of fresh air at workings (Tien, Coal Age 1981).

As a mine gets older, leakage will increase as ventilation pressure increases and ventilation structures deteriorate. To compensate for these losses, additional air has to be handled at fan, which can cause dust problems in airways due to higher velocities. Differential air pressures have been measured across key stoppings and bulkheads. Flow quantities have been determined through mine airways. This data has been used to determine optimal placement of booster fans within the ventilation circuit. Results have been used to calibrate Ventsim and CFD models.

Air flows between two points because pressure differs between these two points. Every stopping or overcast is a potential leaking source and they will leak after a while, especially when subjected to roof pressure. The pressure differential is necessary for delivering fresh air to working sections. Air leakage studies have been focused on the porosity and leakage coefficients of different types of stoppings and seals (Tien, 1996).

The CFD model of the Experimental Mine has been built based on the Ventsim ventilation model. The model contains three sources of leakage. Three dimensional CFD study has been conducted to study the leakage through stoppings and man doors such as the one embedded in the Kennedy portal door. The transient unsteady simulations have been conducted to study the change in the volume flow rate over the passage of the time.

In addition, CFD simulations provide data to investigate leakage rates with and without booster fan in the ventilation circuit.

8.3. THEORY OF THE AIRFLOW MODEL

8.3.1. Modeling Turbulence. There are different ways to model turbulence. In this study, the widely recognized standard k- ϵ model is used for modeling turbulence. The background information of turbulent flow, its modeling methods, and the standard k- ϵ model are introduced as follows. Turbulent flows are characterized by fluctuating velocity fields. Despite the complexity of turbulent flow, exact equations describing the turbulent motion are well known (the Navier-Stokes equations), and numerical procedures are also available to solve these equations.

8.3.2. Standard $k-\epsilon$ Model. The standard k- ϵ model is probably the most widely used turbulence model. It is the simplest of all the “complete” turbulence models because it solves two separate transport equations, which allows the turbulent velocity and length scale to be determined independently. Because of its robustness, economy, and reasonable accuracy for a wide range of turbulent flows, the standard k- ϵ model is widely used in industrial flow and heat transfer simulations. In this research, the standard k- ϵ model was used to simulate underground turbulent flow.

The standard $k-\epsilon$ model is a semi-empirical model based on model transport equations for the turbulence kinetic energy (k) and its dispersion rate (ϵ). The model transport equation for k is derived from the exact equation, while the model transport equation for ϵ was obtained using physical reasoning and bears little resemblance to its mathematically exact counterpart (ANSYS, Inc., 2009).

8.4. SIMULATION METHODOLOGY

8.4.1. Introduction. The objective of the project is to numerically determine airflow distribution inside the underground mine using CFD. There are several commercially available CFD packages. FLUENT software has been chosen because it is the most widely used

CFD software. The pre-processing operations suitable for subsequent CFD simulation like (i) building the geometry, (ii) repairing the imported CAD models (iii) meshing the geometry and (iv) assigning the boundary condition types to the model are carried out using another popular geometry meshing software, GAMBIT. GAMBIT is a pre-processor for geometry modeling and mesh generation.

Once the mesh was read into FLUENT, from GAMBIT, TGRID, Solidworks, or other CAD/CAE packages, all remaining operations were performed within FLUENT. These included setting boundary conditions, defining fluid properties, executing the solution, refining the mesh, and viewing and post-processing the results.

8.4.2. Geometry Modeling and Mesh Generation (Pre-processing). The Missouri S&T Experimental Mine geometric model has been built using GAMBIT software. The model has been simplified for and been repaired to meet mesh quality requirements. The mesh generation has been made by ensuring high density near the leakage slots and in the bounding wall regions where high gradients existed in order to ensure the accuracy of the simulation. Tetrahedral elements have been generated inside the computational domain.

The mesh generation at the leakage regions was difficult due to the complicated shape of them. Hence, interval counts at correspondent edge have been increased and tetrahedral mesh has been used to generate unstructured mesh around these regions. During the mesh generation, the equal-size skewness has been monitored and maintained at a lower value that was suitable for each mesh element type.

After the meshing operation has been completed, boundary types (e.g., walls, inlet, fan, etc.) have been assigned for each surface zone in the computational domain and the fluid/solid zone has been assigned for all volume zones in the computational domain (Zheng, 2011).

After having defined the geometry, the mesh has been produced in an automatic manner using GAMBIT. The computational nodes are uniformly spaced along the boundaries. The mesh

has been generated and has been discretized with GAMBIT using 650,000 to 1,400,000 tetrahedral control volumes (cells), as shown in Figure 8.1. To ensure accuracy of the simulation mesh, generation has been made by ensuring a high density near the slots.

Figures 8.2, 8.3 and 8.4 give graphical background on mesh generation. In all scenarios skewness has been monitored and maintained at the value of 0.9 to ensure calculation convergence (Thiruvebgadam, 2008).

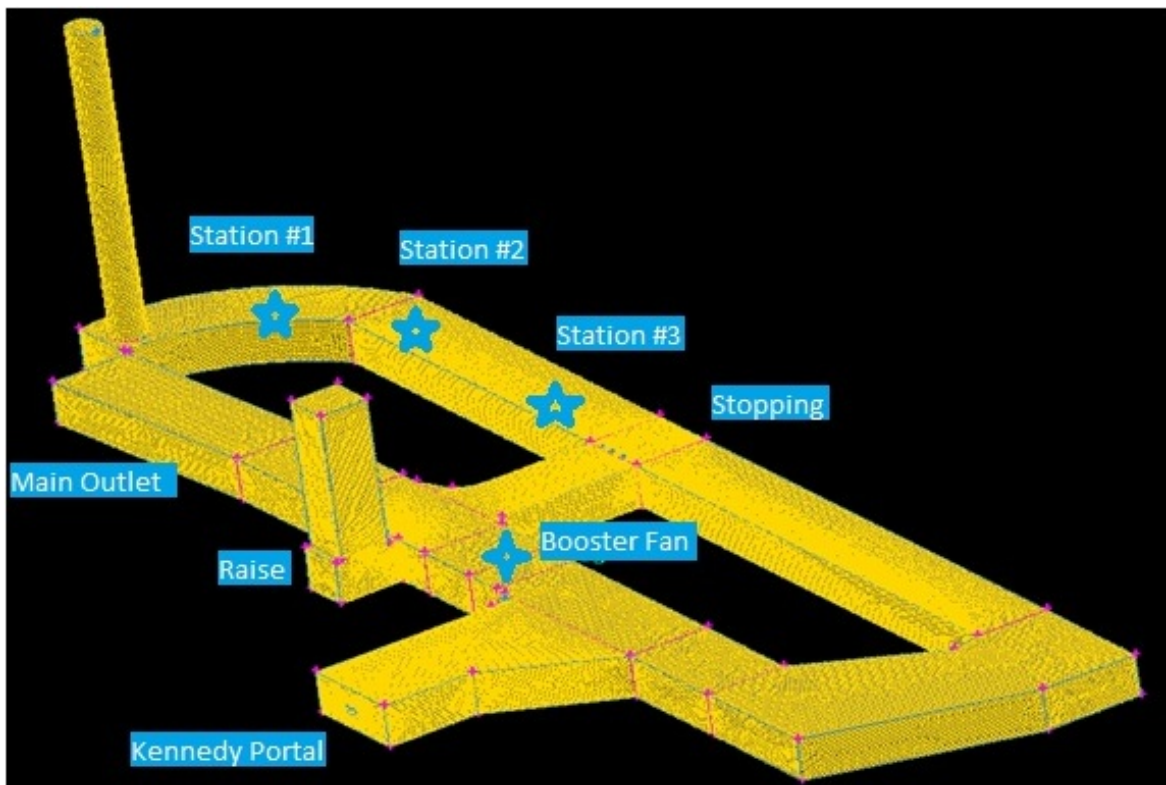

Figure 8.1. CFD model schematic view

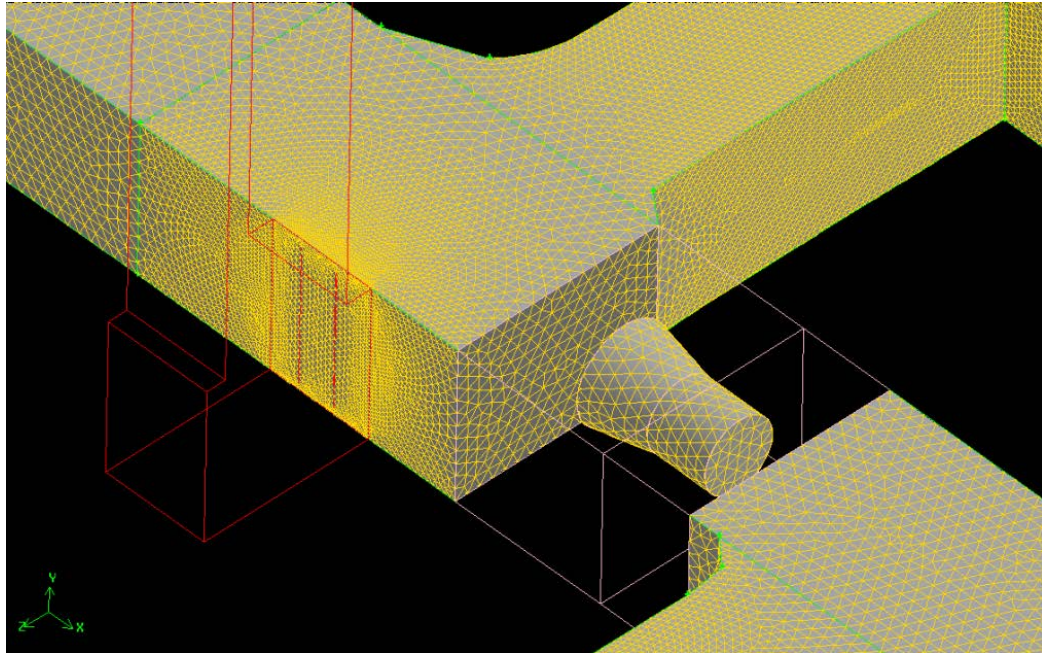

Figure 8.2. Tetrahedral mesh generation of booster fan

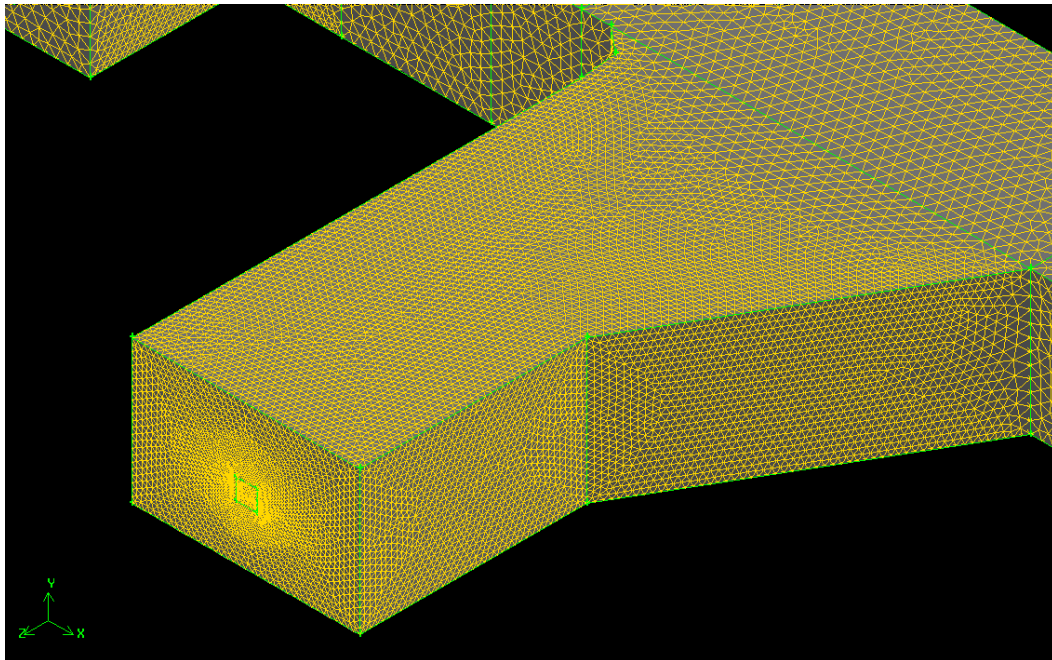

Figure 8.3. Mesh generation at Kennedy portal

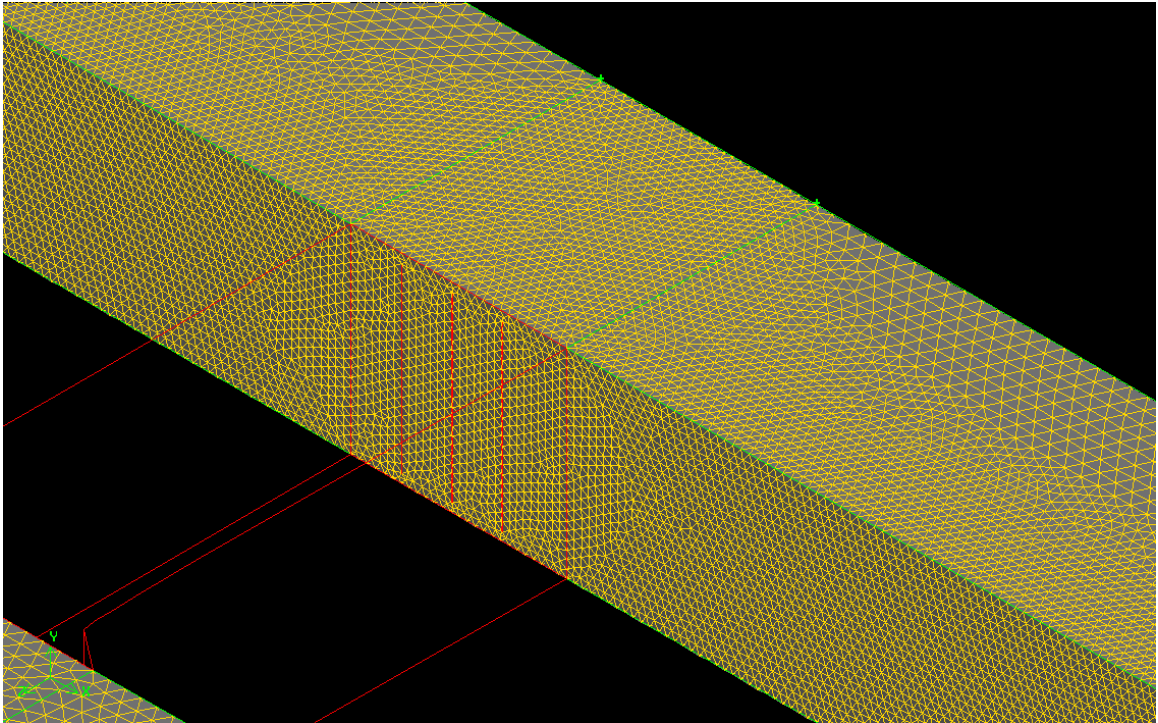

Figure 8.4. Mesh generation at stopping region

Grid independence studies were performed for flow velocity profile using several grid densities and distribution as shown in Table 8.1.

The computational grid is generated using boundary layer meshes to ensure high density near the bounding walls and in the regions of stoppings and fan where high gradients exist in order to improve the accuracy of the simulations. Grid independence tests were performed using different grid densities and distributions shown in Table 8.1.

Comparison of grid 1 and grid 2 shows less than 1% difference for reattachment length. Therefore grid 1 has been used for the purpose of this study.

Table 8.1. Grid independent study

Grid/Model	Number of cells	Velocity (m/s)			
		Stopping	Fan Inlet	Fan Outlet	Main Outlet
1	1,180,293	22.75	22.48	21.45	21.08
2	698,394	21.95	20.13	20.9	20.10
3	982,634	21.52	21.22	21.02	20.55

8.5. GOVERNING EQUATION AND SOLUTION PROCEDURE

8.5.1. CFD Simulation (Solving Process). The mesh file is imported and the CFD simulation carried out using FLUENT. Before starting the CFD simulation the solver type must be chosen. There are two types of solver available in Fluent: (i) pressure based and (ii) density based. The air flow inside the underground mine was incompressible and the pressure based solver, suitable for these types of flow conditions, was used for the DPM distribution calculation. The transient simulation option has been selected to determine time-dependent results. The governing equations and boundary conditions have been assigned. The accuracy of the CFD simulation is dependent on the proper selection of governing equations and boundary conditions (ANSYS, Inc., 2010).

8.5.2. Governing Equations. The simulation involved fluid flow inside the computational domain so the 3D Navier-Stokes equations and continuity equation have been selected. The governing equations of Navier-Stokes have been listed as below:

Continuity Equation:

$$\frac{\partial \rho}{\partial t} + \frac{\partial (\rho \bar{u}_i)}{\partial x_i} = 0 \quad (8.1)$$

Momentum Equation:

$$\frac{\partial (\rho \bar{u}_i)}{\partial t} + \frac{\partial (\rho \bar{u}_i \bar{u}_j)}{\partial x_j} = -\frac{\partial p}{\partial x_i} + \frac{\partial}{\partial x_j} \left[\mu \left(\frac{\partial \bar{u}_i}{\partial x_j} + \frac{\partial \bar{u}_j}{\partial x_i} \right) \right] + \frac{\partial}{\partial x_j} (-\rho \bar{u}'_i \bar{u}'_j) \quad (8.2)$$

Where

u'_i = velocity fluctuation;

u_i^- = average velocity in x direction;

u_j^- = average velocity in y direction;

Turbulence Equation:

k -equation

$$\frac{\partial (\rho k)}{\partial t} + \frac{\partial (\rho k \bar{u}_i)}{\partial x_i} = \frac{\partial}{\partial x_j} \left[\left(\mu + \frac{\mu_t}{\sigma_k} \right) \frac{\partial k}{\partial x_j} \right] + G_k - \rho \varepsilon \quad (8.3)$$

Where:

ρ = density;

k = turbulent kinetic energy;

ε = turbulent dissipation;

G_k = generation of turbulent kinetic energy;

μ_t = turbulence viscosity;

ε -equation

$$\frac{\partial(\rho\varepsilon)}{\partial t} + \frac{\partial}{\partial x_i}(\rho\varepsilon\bar{u}_i) = \frac{\partial}{\partial x_j} \left[\left(\mu + \frac{\mu_t}{\sigma_\varepsilon} \right) \frac{\partial \varepsilon}{\partial x_j} \right] + C_{1\varepsilon} \frac{\varepsilon}{k} G_k - C_{2\varepsilon} \rho \frac{\varepsilon^2}{k} \quad (8.4)$$

Where:

$$\mu_t = \rho C_\mu \frac{k^2}{\varepsilon} \quad (8.5)$$

$$G_k = -\rho \overline{u'_i u'_j} \frac{\partial \bar{u}_j}{\partial x_i} \quad (8.6)$$

$$-\overline{\rho u'_i u'_j} = \mu_t \left(\frac{\partial \bar{u}_i}{\partial x_j} + \frac{\partial \bar{u}_j}{\partial x_i} \right) - \frac{2}{3} \rho k \delta_{ij} \quad (8.7)$$

Model constants appearing in the governing equations

$$C_{1\varepsilon} = 1.44, C_{2\varepsilon} = 1.44, C_\mu = 0.09, \sigma_k = 1.0, \sigma_\varepsilon = 1.3$$

Wall functions are a set of semi-empirical formulas and functions that in effect “bridge” or “link” the solution variables at the near-wall cells and the corresponding quantities on the wall.

The wall functions comprise

- Laws-of-the-wall for the mean velocity and temperature (or other scalars)
- Formulae for the near-wall turbulent quantities

Depending on the choice of turbulent model, ANSYS FLUENT offers three to four choices of wall-function approaches:

- Standard Wall Functions
- Non-Equilibrium Wall Functions
- Enhanced Wall Functions (as a part of EWT)
- User-Defined Wall Functions

The standard wall functions in ANSYS FLUENT are based on the work of Launder and Spalding, and have been most widely used in industrial flows. They are provided as a default option in ANSYS FLUENT (ANSYS, 2009). This approach has been used to solve this problem.

8.5.3. Boundary Conditions. The following boundary conditions have been assigned to investigate the airflow direction along mine airways, stoppings and doors.

- Main surface ventilation fan. The velocity-inlet boundary condition has been assigned for the main fan located at surface. The air velocity has been measured at fan outlet and has been assigned at the correspondence face. The incoming air temperature (T) has been measured and assigned. The turbulent intensity has been assumed to be 10%. The Hydraulic diameter has been calculated and assigned as well.
- Hydraulic diameter. If the duct is noncircular, the analysis of fully developed flow follows that of the circular pipe but it is more complicated. For turbulent flow, the logarithm law velocity profile can be used or the hydraulic diameter is an excellent approximation (White M. Frank, 2007). The hydraulic diameter, D_H , for round cross section can be calculated using the equation below:

$$D_H = \frac{4 \frac{\pi D^2}{4}}{\pi D} = D \quad (8.8)$$

Where the top is the cross sectional area and bottom is the wetted perimeter of the cross section.

For rectangular cross sections, if completely filled with fluid:

$$D_H = \frac{4LW}{2(L+W)} = \frac{2LW}{L+W} \quad (8.9)$$

Where L is the length and W is the width of the cross section.

- **Booster fan.** The boundary condition of a Fan has been assigned at the inlet face of the fan structure to provide the required pressure jump at the determined face. For the purpose of this research the amount of air leakage through the bulkhead has been assumed to be zero. It has been assumed that the bulkhead has been fully sealed so the boundary condition of wall has been assigned for the bulkhead.
- **Kennedy door leakage.** The Kennedy portal is the main portal at the Missouri S&T Experimental Mine that is being used for transportation or mucking purposes. This portal has been sealed by a hydraulic door. The man door has been embedded into the main door and enables miners to pass through. The leakage around the man door is required and outlet ventilation boundary condition has been assigned for the correspondent face. The backflow turbulent intensity has been assumed to be 10 percent and the hydraulic diameter of the leakage has been calculated as 0.35m.
- **Raise outlet.** A booster fan has been installed underground outbye of the junction of a closed raise and stopping and inbye of a portal. The raise has been exposed to ambient pressure on surface and has been sealed by Kennedy stopping underground. The Pressure-outlet boundary condition has been selected and assigned at the face.
- **Shaft and stopping leakage.** Kennedy stoppings have been used to seal the airways at the Experimental Mine. The geometric model includes two stoppings. The shaft leakage is located downstream of the booster fan and the stopping is located upstream. The air leaks through metal Kennedy sheets. The interior boundary condition has been assigned at both faces.
- **Main outlet.** The booster fan increases the pressure and blows the air towards working faces. The pressure-outlet boundary condition has been assigned at the face. The gauge pressure of 120 Pascal has been measured at the point. The hydraulic diameter of 4 meters has been calculated and assigned at the boundary.

- **Turbulence modeling.** The turbulence in the flow was modeled using the Standard k-epsilon turbulence model for both particle tracking and species transport model. Near wall treatment was achieved using standard wall functions. This model was selected over many other turbulence models (k-omega, Reynolds Stress, Large Eddy Simulation etc.) available in the FLUENT package because the model is robust, reasonably accurate for wide ranging flow conditions, and numerically less intensive and stable.

8.5.4. Solution Method. The governing equations and boundary conditions were solved using a numerical technique called Finite Volume Method. The computational domain has been divided into discrete control volumes. The model consists of several control volumes which have been generated in preprocessor GAMBIT. The governing equations have then been integrated over each control volume of the computational domain (Zheng, 2011).

The following are the discretization schemes have been assigned in FLUENT:

- The pressure correction equation obtained from the continuity equation has been discretized using the Second Order method. The other methods available in FLUENT are Standard, First Order, PRESTO and Body force Weighted.
- The gradients in the governing equations have been solved using Least Squares Cell Based technique. The other methods are (Green Gauss Cell Based and Green Gauss Node Based).
- The convection terms in the governing equations (momentum, turbulence, and energy) have been discretized using the Second Order Upwind scheme. This technique was used because it was second order accurate. The other methods available in FLUENT are First Order Upwind, Power law and Quick.
- The First Order Implicit method was used for time discretization. The other method was Second Order Implicit.

The final step was the solution of the algebraic equations using an iterative method. The pressure and velocities in the momentum algebraic equations were coupled and this coupling was achieved using the SIMPLE (Semi-Implicit Method for Pressure-Linked Equations) algorithm. This was the commonly used algorithm to solve all the discretized governing equations sequentially in an iterative approach to arrive at the final converged solution.

The model has been set up in FLUENT and initialized as below:

The unsteady flow calculations were made using time step ($\Delta t = 0.01$ s) and 20 iterations for each time step. The convergence criterion required that the scaled residuals be smaller than 10^{-4} for the mass, momentum, scalar turbulence and smaller than 10^{-9} for the energy equation.

8.5.5. Analysis (Post Processing). Analysis of the CFD simulation data has been done by FLUENT post processing software to obtain useful results. In the post processing stage, the following results were obtained:

- Colored contours showing pressure and velocity distributions, etc. in the face area;
- Velocity vectors colored by suitable flow variables showing the fluid flow pattern;
- Streamlines (generated from the velocity vectors) to visualize more vividly the flow pattern and recirculation regions;
- Generated x-y plots to determine pressure and velocity anywhere inside the flow domain.

8.6. RESULTS AND DISCUSSION

The CFD simulations have been conducted to analyze the effect of booster fans on the ventilation network. Specifically the study has been conducted to investigate the airflow behavior up and downstream of a booster fan.

For the purpose of this study two scenarios have been considered. The first scenario is the Missouri S&T Experimental Mine CFD model in which the booster fan has been excluded. The booster fan has been added to the circuit in the second scenario.

The results of the simulation have been verified by the experiment.

8.6.1. Scenario 1 (Booster Fan Excluded). The simulation has been conducted and the results have been calibrated with the actual Pressure-Quantity field survey results. In FLUENT, the stopping gates may be modeled either as porous jumps, or, if the plate is thin, as porous jumps. However in this case, assigning porous jump as the boundary condition for stoppings wouldn't be applicable since the stoppings has been fully sealed and the pressure jump does not occur through a specific region.

The Bulkhead/Booster Fan/Fan Wall boundary conditions have been changed to interior to simulate the “no fan” scenario. Table 8.2 shows the experiment and CFD model correlation average quantities.

The simulation results show that the air flows into the mine through the main mine ventilation shaft then flows towards the stopping. The small portion of air leaks through stopping. The amount of $0.2\text{m}^3/\text{s}$ has been measured. Air then travels towards the Kennedy door that has high resistance. $0.4\text{m}^3/\text{s}$ of air leaks through Kennedy man door. The air travels toward the main outlet but on its way $0.3\text{m}^3/\text{s}$ leaks to the ventilation raise. Figures 8.5 and 8.6 show the velocity and pressure pathline and airflow distribution in the mine.

Table 8.2. Comparison of experimental and CFD simulation results

Model	Stations						
	1	2	3	Stopping Leakage	Kennedy Portal	Raise Leakage	Main outlet
Experiment	20.8	20.8	20.8	0.2	0.3	0.3	19.7
CFD	20.8	20.7	20.4	0.12	0.2	0.2	20.5
Difference%	0	0.5	2	66.7	50	50	3.9

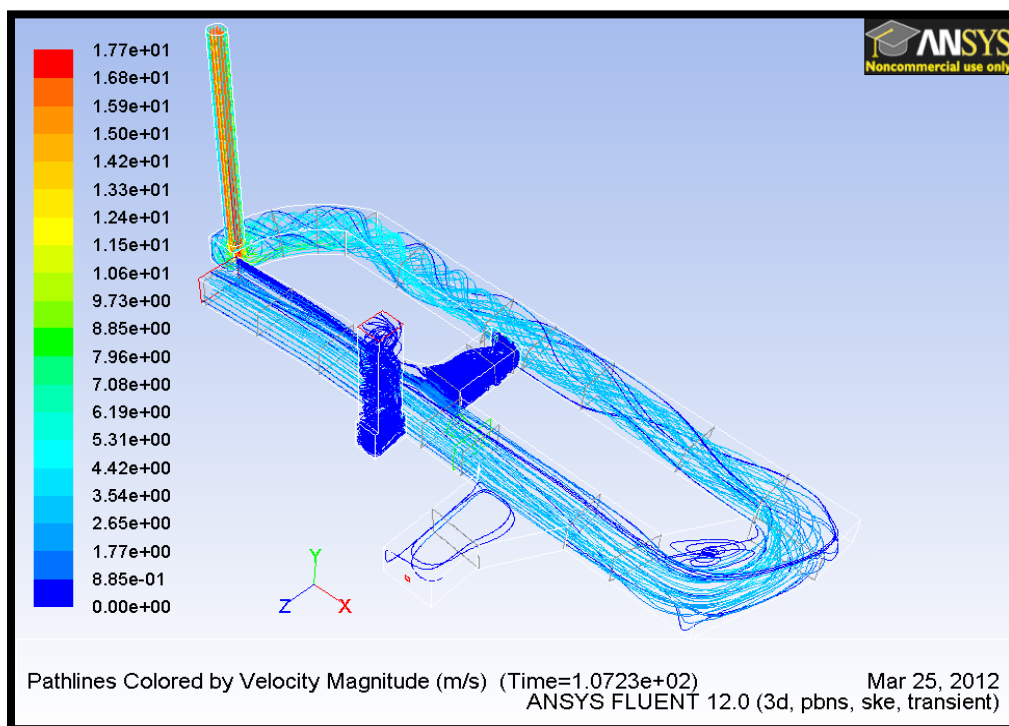

Figure 8.5. Velocity pathlines distribution

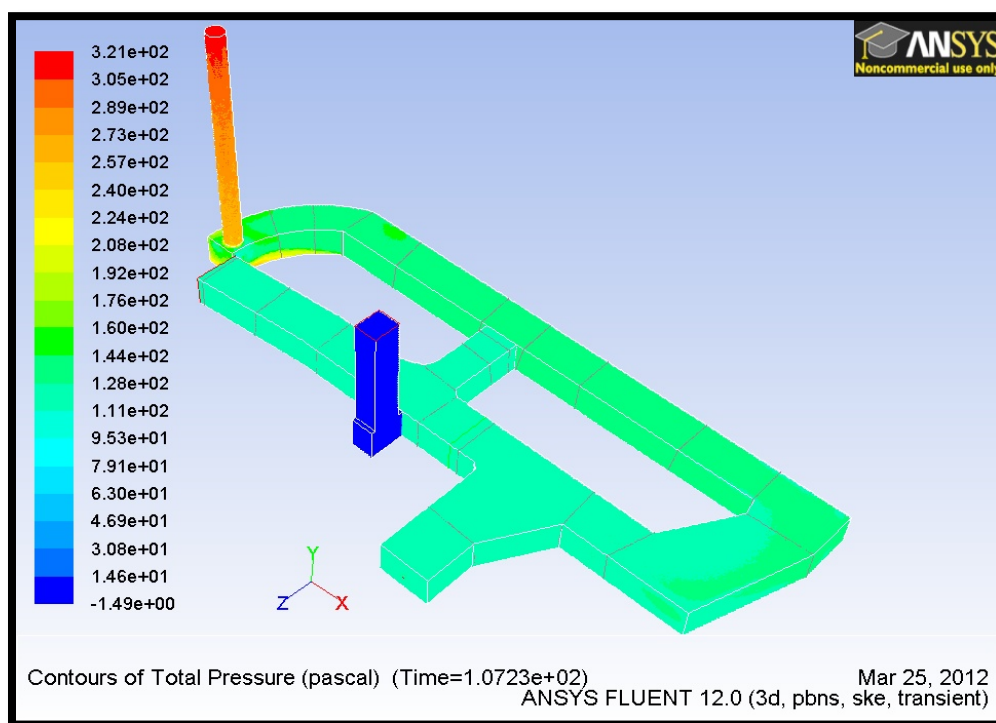

Figure 8.6. Total pressure distribution contours

To obtain pressure gradients along the circuit several planes have been created in airways. The area-weighted average total pressure for each plane has been calculated and the pressure gradient has been generated. Figure 8.7 shows the pressure gradient graph.

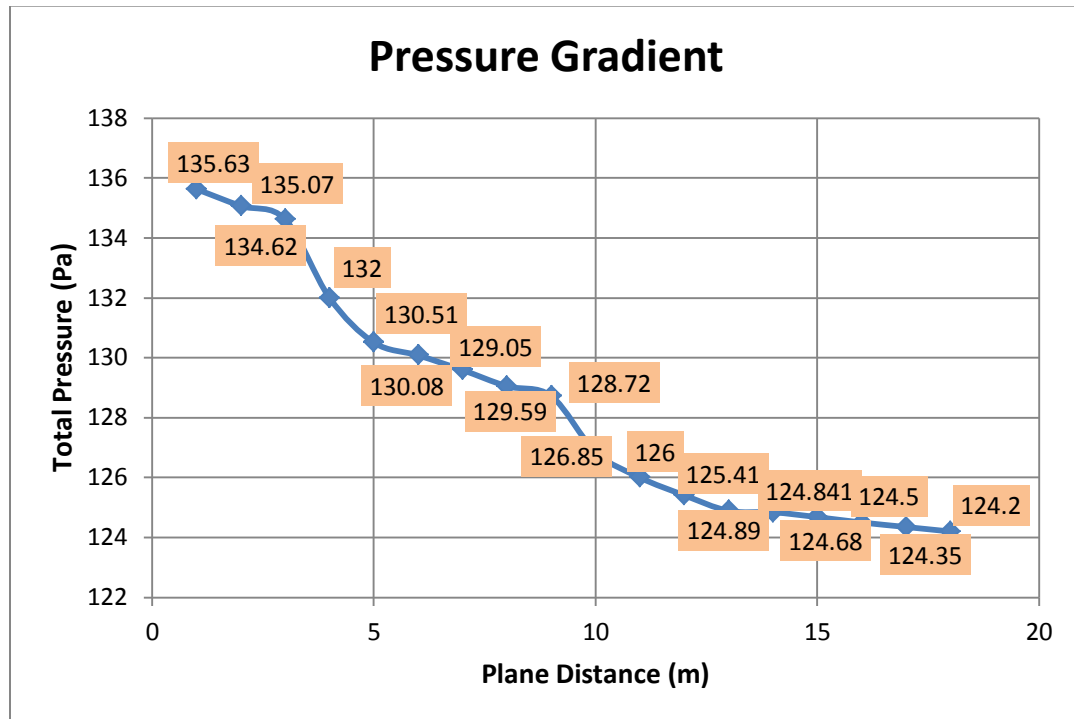

Figure 8.7. Pressure gradient without booster fan

Effort has been put to determining the area correspond to each stoppings. The amount of leakage through stoppings and Kennedy man door has been adjusted by altering the area of the openings at each boundary condition. The air leaks through the stoppings, Kennedy door and shaft door. Figure 8.8 shows the velocity magnitude vectors at each region.

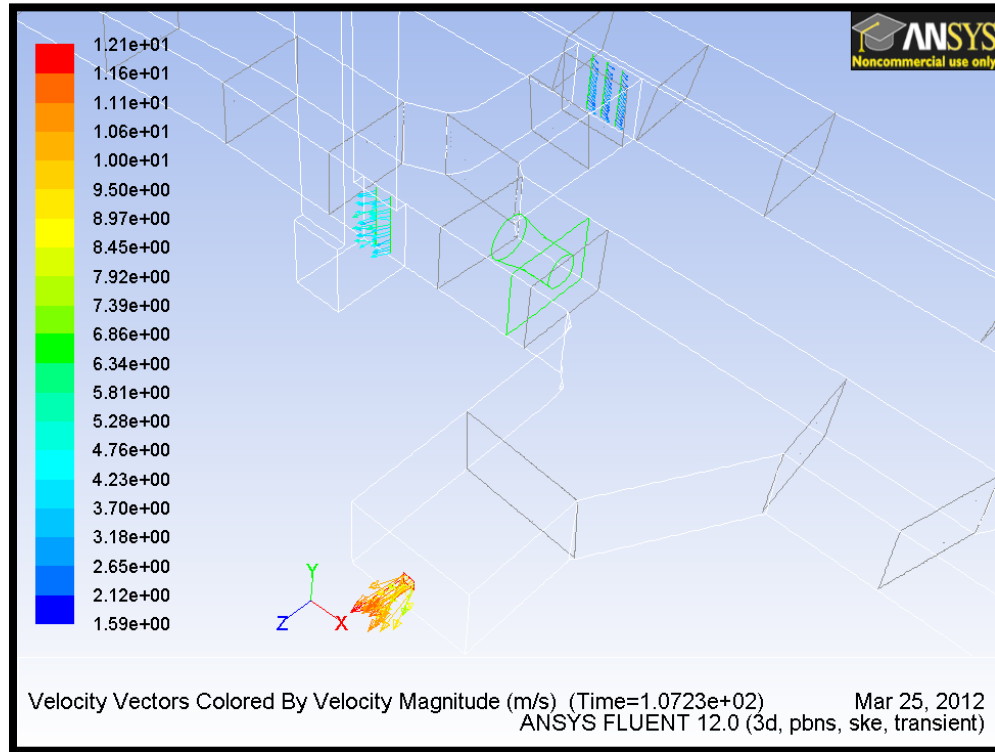

Figure 8.8. Velocity vectors through stoppings and doors

Pressure gradient aids in determining regions of excessive resistance and the feasibility of correcting the conditions causing them by cleaning airways, driving additional ones, or modifying existing ones. The pressure gradient is also useful for predicting the effect on other parts of the system when adjusting air regulation on any one split or when planning a new air shaft, slope, or drift.

Pressure measurements in underground mines can be made on either an absolute or a differential basis. Measurements made on absolute basis at each station are subtracted, one from the other, to find the head loss between stations.

8.6.2. Scenario 2 (Booster Fan). The Fan boundary condition has been assigned to the booster fan inlet face. A constant pressure jump of 500 Pascal across the booster fan has been assigned. The bulkhead has been assumed as a wall with high resistance and no leakage. The outlet-vent boundary condition has been assigned at Kennedy portal. The transient unsteady simulation has been conducted to analyze the effect of booster fan on leakage volume flow rate.

The results of the simulation show that the booster fan will change the airflow direction at Kennedy door. In addition, the fan also changed the direction of airflow through stoppings. The amount of $0.15\text{m}^3/\text{s}$ has been simulated and measured at the Kennedy portal. This results in recirculation in the ventilation network. The amount of volume flow rate at shaft leakage has also been increased. To decrease the amount of leakage the resistances of stoppings have been improved by taping the joints.

The CFD simulation results have been verified by the experiment measurements. Table 8.3 shows the calculated volume flow rates from CFD results and the measured airflow quantities experiment and CFD model correlation using volume flow rate (m^3/s). Figure 8.9 shows the velocity pathlines across the domain.

Table 8.3. Comparison of CFD simulation and experimental results (with booster fan)

Model	Station Quantity (m^3/s)							
	1	2	3	Stopping Leakage	Kennedy Portal	Raise Leakage	Main outlet	Booster fan
Experiment	21.3	20.8	20.8	0.4	0.2	0.9	19.2	21.9
CFD	20.7	20.52	20.72	0.34	0.15	0.6	20.9	21.4
Difference	2.6	1.4	0.4	17.6	33.3	50.0	8.1	2.3

The pressure gradient graph has been generated by plotting the area-weighted average total pressure for each plane. Figure 8.10 shows the pressure distribution.

The contours show the abrupt pressure jump at the location of the booster fan. The pressure drops as the air enters underground and travels towards booster fan. The colors show the significant pressure in by the booster fan.

Planes have been created across the model (Figure 8.11) to measure different values across the domain. The area weighted average total pressure has been derived across the planes which have been located in the main ventilation path. The results then have been analyzed and have been used to plot the pressure gradient.

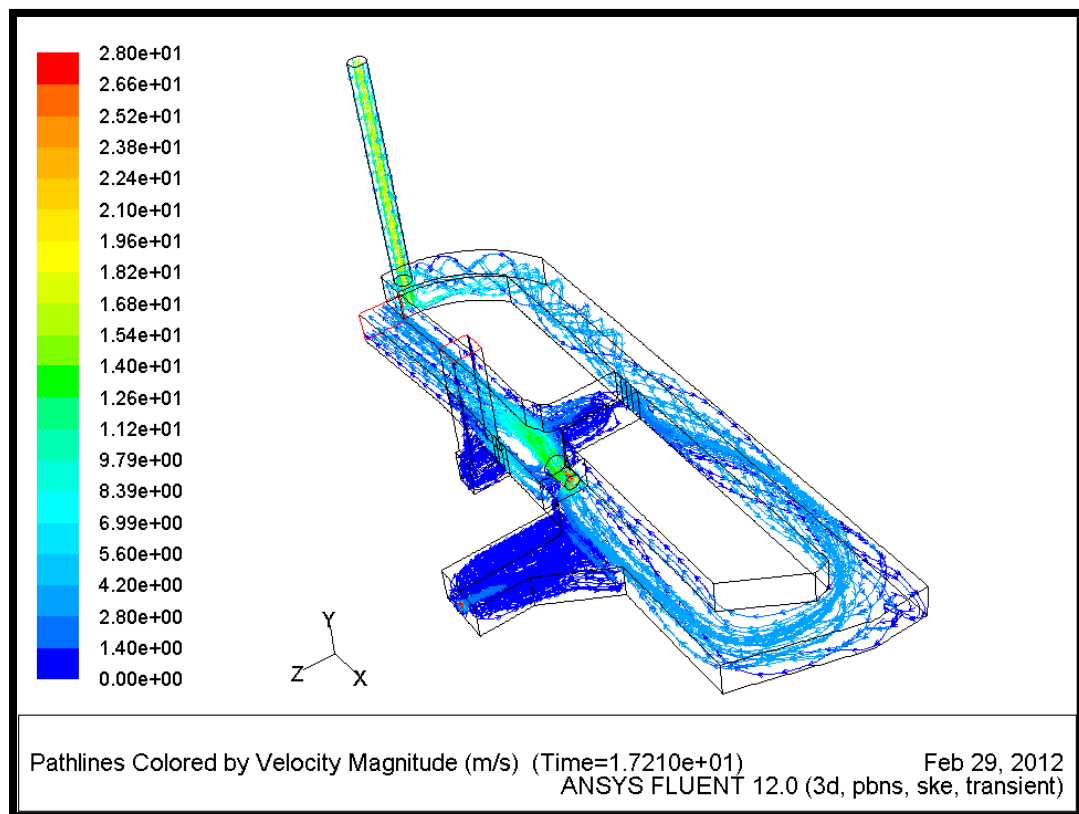

Figure 8.9. Velocity pathlines across the domain

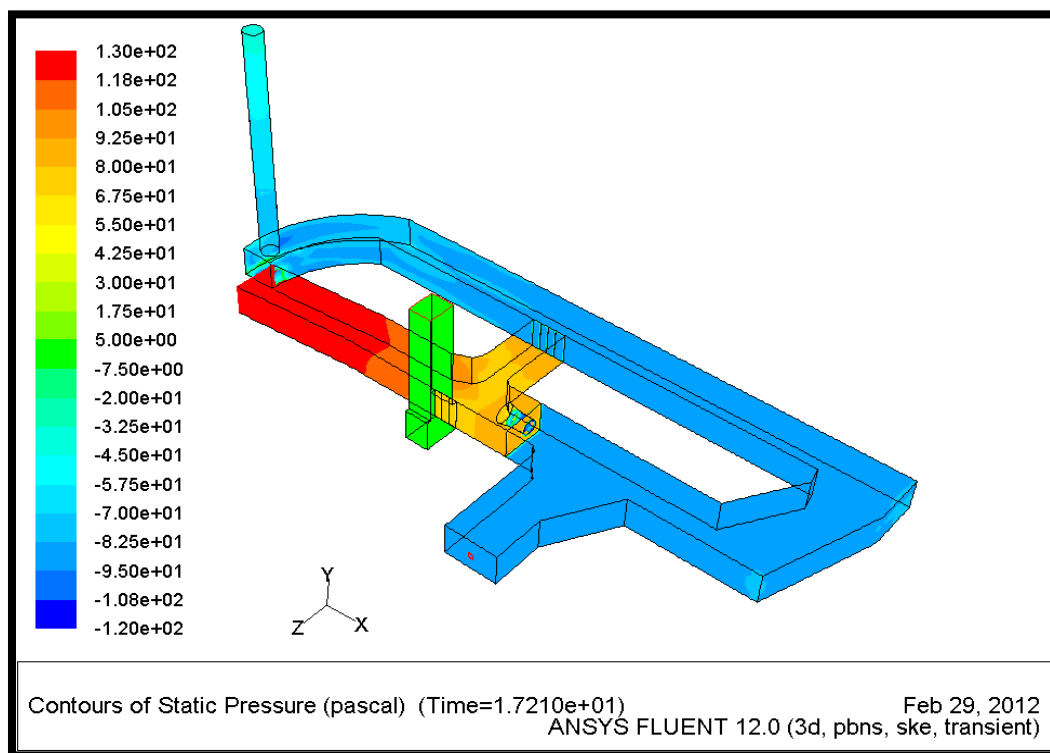

Figure 8.10. Pressure distribution contours across the domain

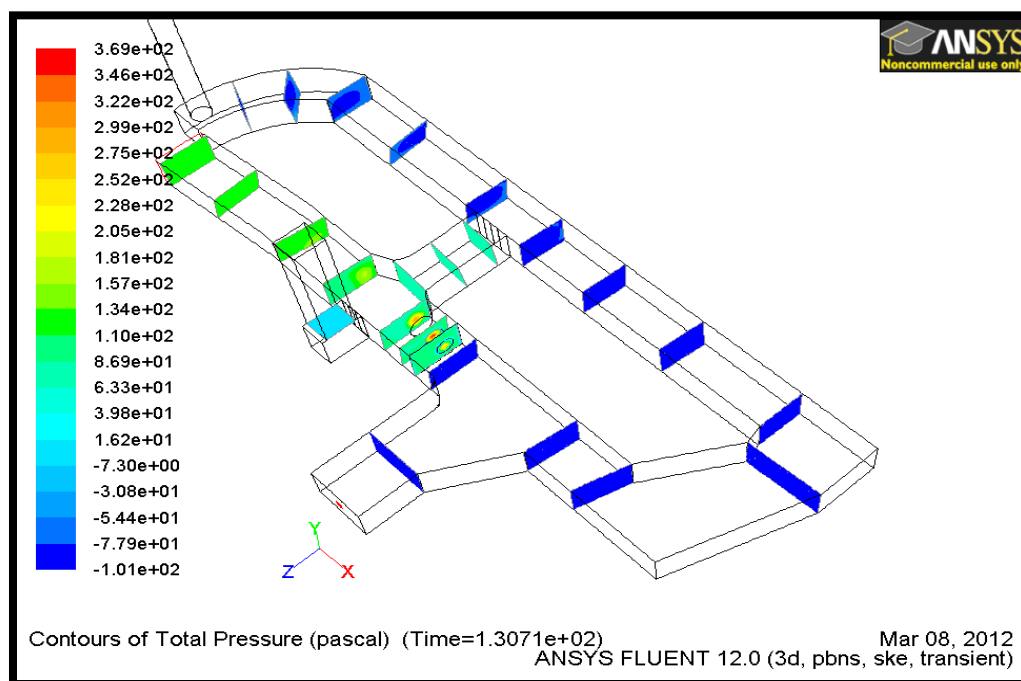

Figure 8.11. The created planes across the models

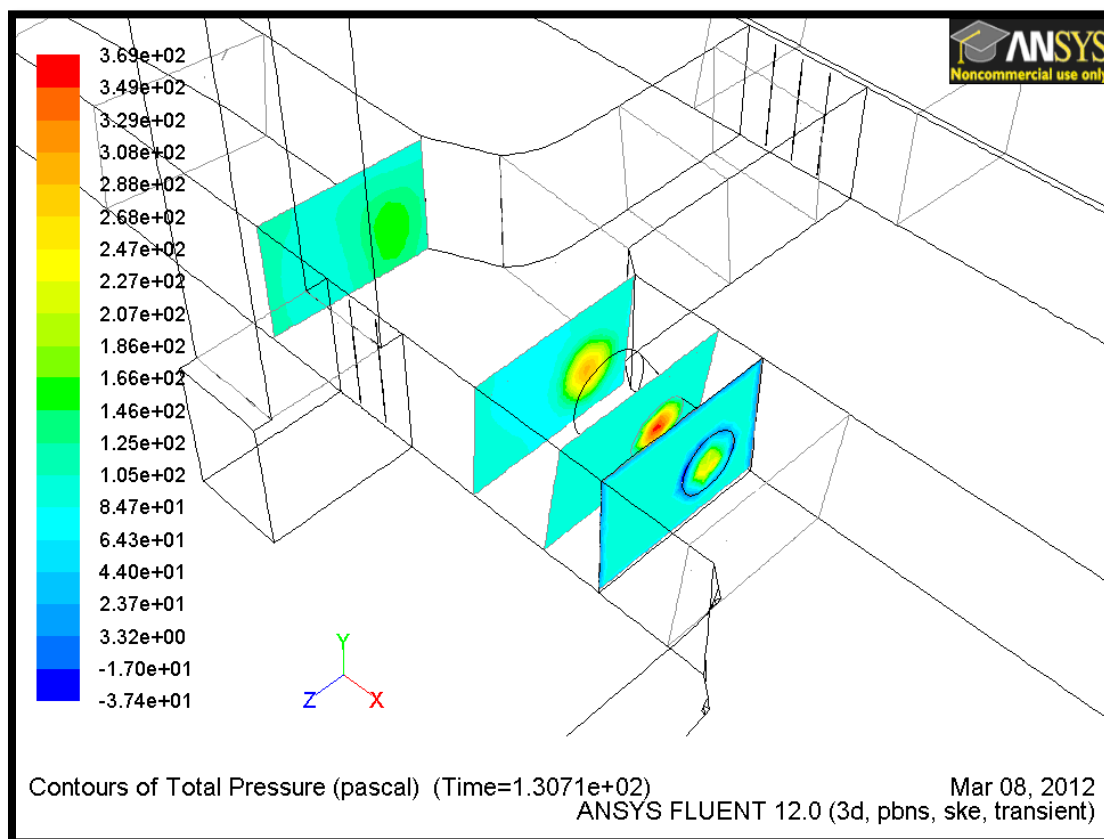

Figure 8.12. Area-weighted average total pressure downstream to the booster fan

The results from CFD simulations have been imported to Excel and total pressure gradient across the mine has been created. Figure 8.13 shows the pressure gradient versus the planes distance. When changes occur in the area of airways in a mine ventilation system the velocity head will vary at different points in the system. The mine and fan static pressure and velocity heads are rarely equal. Based on the geometry there is a sudden expansion before it contracts to become uniform sized duct from where the flow exits through the outflow boundary. Due to the sudden contraction in the duct after the expansion region, the flow velocity increases (also the velocity pressure) and static pressure decreases. But flow starts redeveloping and starts filling the entry. Therefore velocity pressure drops and static pressure starts to increase. Once the

entry region is filled, the velocity will gradually attain fully developed value far downstream from the shock loss area and static pressure will start to decrease again due to the frictional losses in the airway. This flow behavior is due to the turbulent eddies that are generated around the sudden expansion and contraction regions.

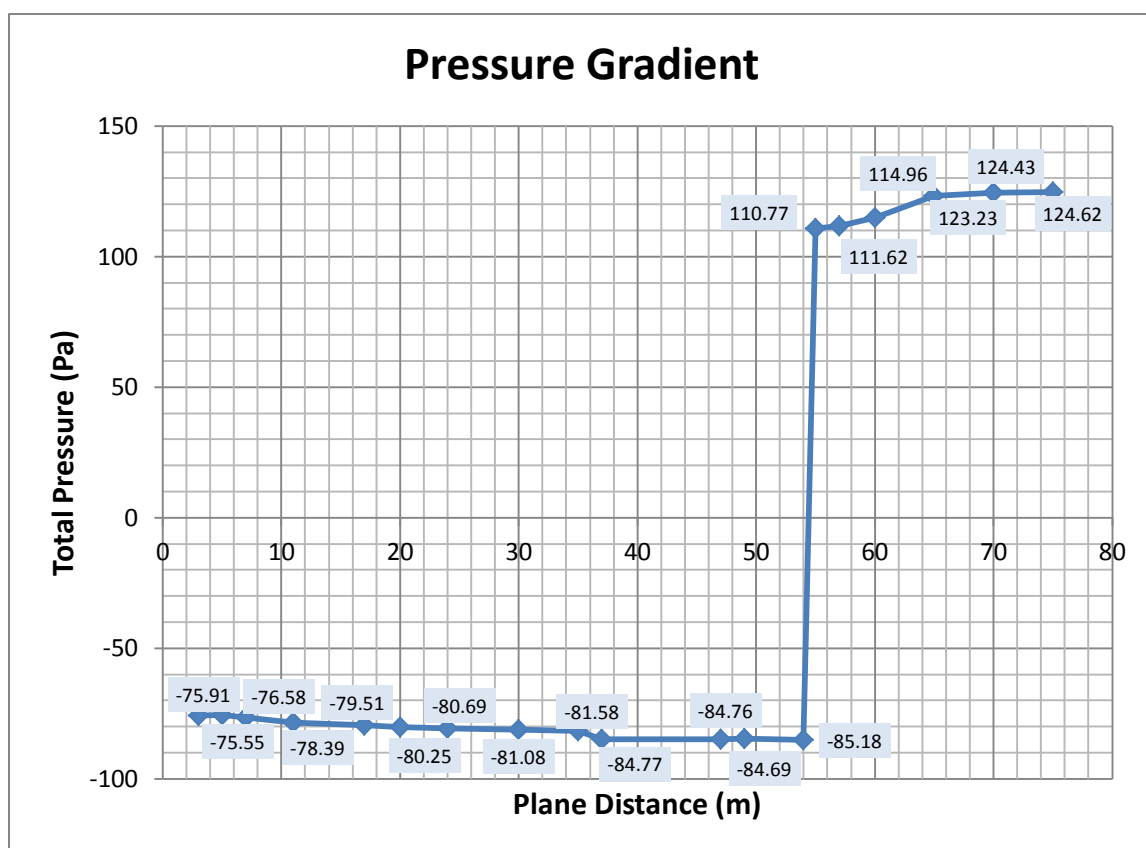

Figure 8.13. Pressure gradient with the presence of booster fan

In the Missouri S&T Experimental Mine case, the areas on the both sides of the booster fan are almost equal. The booster fan increased the pressure and velocity which changes the velocity head. Figure 8.14 shows the velocity vectors at the stoppings and Kennedy door region.

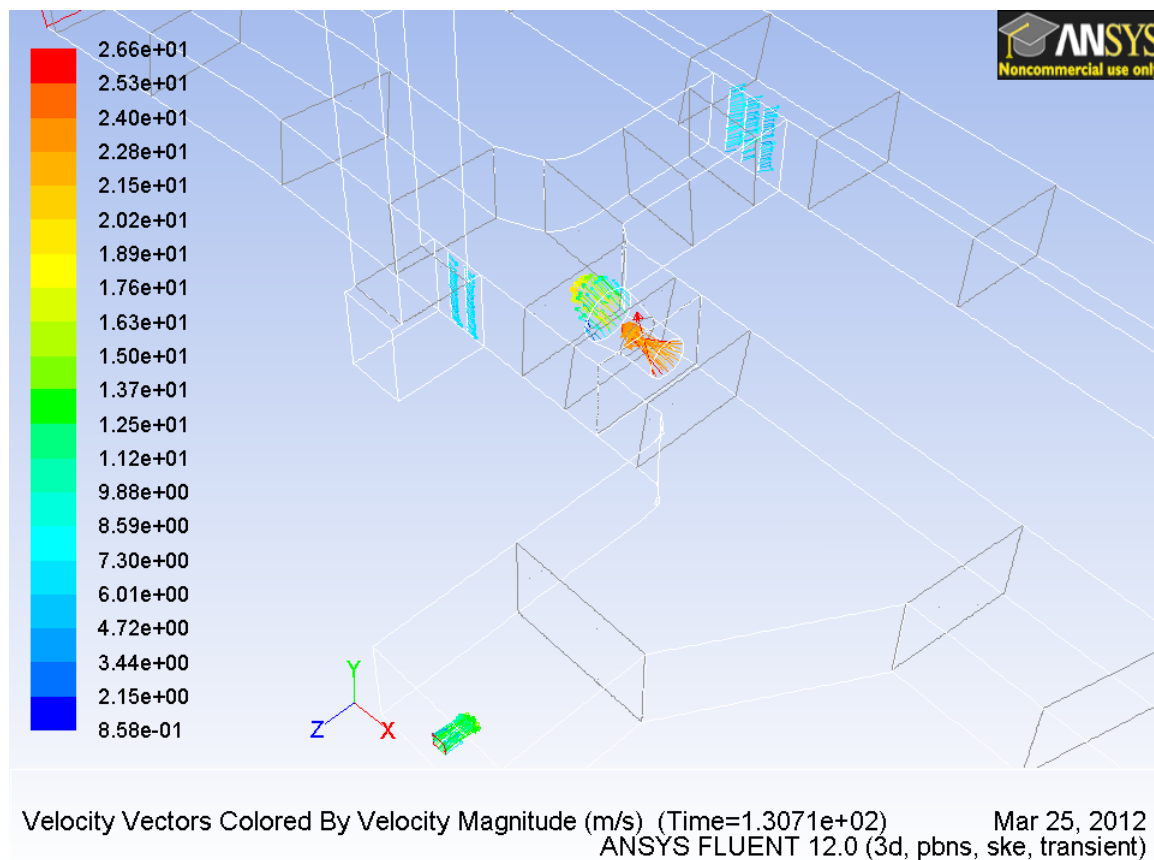

Figure 8.14. The velocity magnitude vectors at leakage regions

8.7. CONCLUSION OF SECTION

A CFD approach has been used to analyze the effect of booster fans in a ventilation circuit. The results in the Experimental Mine example show that the airflow direction has been changed at Kennedy portal and the pressure jump caused by the booster fan sucks the air into the mine. The airflow direction also changes at stoppings located downstream to the booster fan. A small amount of air leaks through the stopping which as the results show results in recirculation. The amount of leakage at the raise door has also been increased.

Building a proper geometric model for simulating leakage was very difficult. The “interior” boundary condition has been assigned to model the leakage. The pressure quantity and

pressure drop across the model has been calculated. The results have been used to calculate the area of the leakage airflow area for every stopping and the Kennedy door.

One of the difficulties that is encountered in using Fluent for a real-world scale model is that of accurately accounting for wall roughness. The Fluent User's Guide gives some guidance into assigning accurate wall roughness coefficients for smooth-surfaced as well as for tightly-packed, uniform sand-grain roughness, but further states that a clear guidance for choosing the proper roughness constant for arbitrary types of roughness is not available.

Fluent also has the capability for input of fan curve data rather than simply applying constant velocity at the inlet face as done in this study. This would yield more accurate results.

9. CONCLUSIONS

A booster fan, when properly sized and sited, can be used to assist mine surface fans to overcome high resistances and to ventilate isolated working districts. To accomplish this objective, the fan must be installed in a permanent bulkhead and equipped with airlock doors, self-closing doors and a monitoring system.

Uncontrolled recirculation is the main hazard associated with the utilization of a booster fan. Recirculation is induced when the booster fan is not sized or located properly. It can be prevented with proper planning and fan selection. Recirculation can also be caused by the stoppage of main fans while the booster fan is still operating. To prevent this, booster fans should be equipped with electrical interlocks wired to cut off the power to the booster fan in the event of main fan failure.

Monitoring is a basic component of a booster fan system. It is used to determine the quality and quantity of air in the working areas and the operating conditions of the fan. With the advent of reliable monitoring systems, booster fans can now be operated safely and efficiently. Each fan must be provided with standard operating procedures for starting and stopping the fan, changing fan duties, and for scheduled maintenance. These procedures should be reviewed with end users and updated periodically.

It can be seen that with the use of available technologies booster fan installations have been operated in controlled and safe manner in Australia, the United Kingdom and other major coal mining countries. Legislative restrictions such as restricting use of booster fans could force the closure of sub economic operations. The use of booster fans has far greater savings than those demonstrated in the Australian and United Kingdom examples if their use facilitates the continued working of an operation that is being considered for closure. These factors should be considered as part of a complete economic assessment of existing or proposed ventilation designs.

It is of interest that Australia, the United Kingdom and South Africa have been leaders

within the international mining industries in adopting systems of safety risk management. The onus for responsibility is placed with the mine operator who must prove he is aware of requirements to achieve operational behaviour at a standard of world's best practice and accept responsibility. Potential hazards that may occur in use of booster fan systems must be assessed by implementing risk management procedures. The onus of responsibility requires that all safety issues in a particular situation must be assessed and written safety systems utilized.

Construction of a booster fans system structure is an important task. The pressure drop across the bulkhead can cause leakage across the bulkhead which may lead to recirculation. This will reduce the efficiency of the booster fan. Two booster fans were installed at the Missouri S&T Experimental Mine. All stoppings and bulkhead were sealed as much as possible for the purpose of this study and all models were calibrated with experimental measurements. The additional volume flow rate has been measured at the assumed working face of the Experimental Mine by sealing and taping the stoppings.

It was seen that the air quantity at the assumed working face was increased. The optimal scenario was determined to be the one that reduces the operating cost while maintaining more flow rate at the working face.

Booster fans could be one of the solutions for improving a ventilation network. However, it is not the only one. All other alternatives should be taken into account. The feasibility studies for future planning play a significant role to determine the optimal way for upgrading a ventilation network.

CFD analysis of data demonstrates that the airflow direction, pressure drop and the amount of leakage across the stoppings up and down stream of a booster fan system is affected by the additional pressure jump imposed by a booster fan. In systems with a single booster fan, widening the entries near the booster fans may help to produce more symmetric flows.

Three-dimensional CFD models of a booster fan ventilation system are useful in identifying the detailed flow characteristics of booster fan systems including the effect of the neutral airways on recirculation. In addition, it is very important to provide meaningful data on the porous characteristics of structures that lead to leakage based on.

BIBLIOGRAPHY

1. Anon., 2009. Mining Cost Service, Vol II, Cost Mine, InfoMine USA Inc, Published by Western Mine Engineering, Inc.
2. Anon., 2010. Mine and Mill Equipment Costs 2010, Cost Mine, InfoMine USA Inc, Published by Western Mine Engineering, Inc.
3. ANSYS, Inc., 2009, ANSYS FLUENT 12.0 Getting Started Guide. ANSYS Workbench 12.0, ANSYS, Inc.
4. ANSYS, Inc., 2009, ANSYS FLUENT 12.0 Theory Guide. ANSYS Workbench 12.0, ANSYS, Inc.
5. Ashelford, D., 2009. *Remote Operation of Dilution Louvers*, PowerPoint presentation, BHP Billiton.
6. Burnett, R.L. and Mitchell, D. 1988. *The Safe Use of Controlled Recirculation Techniques in the Ventilations of United Kingdom Coal Mines*. Proc. of the 4th International Mine Ventilation Congress.
7. Burrell, R.A., and Bennett S.C., 1995. "Recent developments in the ventilation of coal mines." Coal International, Vol 243, No. 4, Jul., pp. 147-150.
8. Calizaya, F. 2009. *Guidelines for installing and operating booster fans in underground mines*. Proceedings of the Ninth International Mine Ventilation Congress. New Delhi, India: Oxford and IBH.
9. Calizaya, F. and Stephens, M., 2006, "Studies of leakage flow in the U.S. underground coal mines," Proceedings of the 11th U.S./North American Mine Ventilation Symposium, Penn State University, University Park, PA, pp. 599-606.
10. Calizaya, F., M.J. McPherson, and P. Mousset-Jones. 1987. *An Algorithm for Selecting the Optimum Combination of Main and Booster Fans in Underground Mines*, Proceeding, 3rd U.S. Mine Ventilation Symposium, Littleton, CO: SME.
11. Calizaya, F., Stephens M, Gillies A. D. S., *Utilization of Booster Fans in Underground Coal Mines*, SME Annual Conference, March, 2010, Phoenix, Arizona.
12. Federal Register, 2007, Report of Investigation: *Fatal Underground Coal Mine Explosion*, January 2, 2006, Sago Mine, Wolf Run Mining Company, Upshur County, West Virginia, ID No. 46-08791, Mine Safety and Health Administration.
13. Gamble, G. 2012. Personal Correspondence, www.twincityfan.com, accessed April 24, 2012.
14. Gillies, A. D. S., Calizaya, F. and Slaughter, C., 2010. "Booster Fans – Some Considerations for their Usage in Underground Coal Mines," Proceedings, 13th US Mine Ventilation Symposium, Eds S. Hardcastle and D. L. McKinnon, Sudbury, Ontario, June 2010 pp511-518.

15. Gillies, A.D. S, Calizaya, F, 2012 “*Use of Underground Booster Fans in Foreign Prominent Coal Mining Countries Compared With The Ban in The United States,*” Proceeding, 14th US Mine Ventilation Symposium, June 2012.
16. Hartman, H.L., Mutmanský, T.M, Ramani, R.V., and Wang, Y.J., 1997, *Mine Ventilation and Air Conditioning*, Third Edition, New York: John Wiley and Sons.
17. Jobling, S., Yates, C., Lowndes, I. S. and Yang, Z.Y., 2001. *The Integration Of The Ventilation Networks of The North Selby and Stillingfleet Mines*. In S. Wasilewski (ed.), Proc. Of the 7th International Mine Ventilation Congress, Proc., Krakow, 17-22 June 2001, Katowice:EMAG.
18. Kennedy, W., 1196, *Practical Mine ventilation*, Chicago, Illinois: Intertec Publishing.
19. Krog. R. B, “*Selection of Underground Booster Fans,*” Proceedings of the North American/Ninth US Mine Ventilation Symposium, Kingston, Canada, 8-12 June 2002, Edited by Euler De Souza, Taylor & Francis 2002, ISBN:978-90-5809-387-5.
20. Lauriski, D. And Yang, B. “*Is the System of Mine Safety and Health in the US Broken*”, *Mining Engineering, SME*” July 2011, pp77-82.
21. Martikainen, A.L., and C.D. Taylor. 2010. *Breaking the Ice on the Booster Fan Dilemma in US Underground Coal Mines*, *Mining Engineering* 62(10): 47-53, Denver, Colorado, USA.
22. McElroy, G. E, Kingery, D S., *Making Ventilation-Pressure Survey With Altimeters*, U.S Dept. of the Interior, Bureau of Mines, National government publication, 1957.
23. McPherson, M.J., 1993. *Subsurface Ventilation*, London: Chapman Hall.
24. Moll, A.T., and Lowndes, I.S., 1994. “*An approach to the optimization of multi-fan ventilation system in U.K. coal mines.*” *Journal of the Mine Ventilation Society of South Africa*, January: pp. 2-18.
25. Oswald, N, B. Prosser and R. Ruckman, “*Measured Values of Coal Mine Stopping Resistance,*” in 12th U.S./North American Mine Ventilation Symposium- Wallace (ed), University Park, Pennsylvania, 2008.
26. Robinson, R., 1989. “*The use of booster fans and recirculation systems for environmental control in British coal mines.*” Proceedings of the 4th U.S. Mine Vent Symp. M.J. McPherson, ed., SME, Littleton, CO, pp. 235–242.
27. Saxton, I., 1986. *Coal Mine Ventilation from Agricola to the 1980's*. Part VIII, Mining Eng., Gullick Dobson Ltd., London, pp. 395–405.
28. Singh, A.K., Ahamad, I., Sahay, N., and Varma, N.K., 1999, “*Air leakage through underground ventilation stoppings and in-situ assessment of air leakage characteristics of remote filled cement concrete plug by tracer gas technique,*” *Journal of the Mine ventilation Society of South Africa*, July/September, pp. 102- 106.
29. *SME Mining Engineering Handbook*, Volume 1, pp 1090 , By Howard L. Hartman, Seeley W. Mudd Memorial Fund of AIME., Society of Mining, Metallurgy, and Exploration (U.S.) 1992.
30. Spendrup Fan Company. 2012. www.spendrupfanco.com, accessed April 24, 2012.

31. Stebbins, S. A. 2011. *Cost Estimating for Underground Mines*, SME Mining Engineering Handbook, Third Edition, Ed. Darling, P. Society of Mining, Metallurgy and Exploration, Denver, Colorado, USA pp263-280.
32. Thiruvengadam M, “*Three-Dimensional Laminar and Turbulent Convection in Separated Flow.*” PhD dissertation pp. 127, Missouri University of Science and Technology 2008.
33. Tien J, “*Air Leakage Costs.*” *Coal Age* Sep 1996, Vol 101, Issue 9, pp. 88.
34. Tien, J., *Mine Ventilation Lecture Notes*, 2011.
35. Tien, J.C. 1981. “*Metal Stoppings Reduce Air Leakage,*” *Coal Age*, Apr., pp. 74-77.
36. Title 30 Code of Federal Regulations. 30 CFR 75.302. 12/2010, USA.
37. Ventsim Visual™, 2012, *Ventsim Visual™ User Guide*, Ventsim Company.
38. Weiss, E. S., Greninger, N.B., Stephan, C.R., and Lipscomb, J.R., 1993, *Strength Characteristics and Air-Leakage Determinations for Alternative Mine Seal Designs*, National Institute for Occupational Safety and Health Report of Investigation RI-9477.
39. Wempen Jessica M, “*Characterization of Air Recirculation in Multiple Fan Ventilation systems,*” Master’s Thesis, University Of Utah May 2012.
40. Wempen, J. M., Calizaya, F., Peterson, R. D. and Nelson, M. G., *Evaluating the Use of Booster Fans in Two Underground Coal Mines*. SME Annual Conference, 2011, Society of Mining, Metallurgy and Exploration, Denver, Colorado, USA.
41. White, Frank M., “*Fluid Mechanics,*” 7th Ed, Published by The McGraw-Hill Company, Inc. Chapter 6, pp. 379-382.
42. Zheng Yi, “*Diesel Particulate Matter Dispersion Analysis In Underground Metal/Nonmetal Mine Using Computational Fluid Dynamics.*” PhD dissertation Chapter 6, pp. 125. Missouri University of Science and Technology 2011.

VITA

Arash Habibi Javanbakht completed his higher secondary education in Tehran, Iran in 2000. He joined Tehran Azad University of Southern Tehran and obtained his Bachelor degree in Mining Engineering in 2006. Mr. Habibi joined Missouri University of Science and Technology in 2010 to pursue a Master of Science degree in the Mining Engineering program. He has held the positions of Graduate Research Assistant and Graduate Teaching Assistant since August 2010.

